

**HISTORY AND DEVELOPMENT  
OF THE 567 SERIES GENERAL  
MOTORS LOCOMOTIVE ENGINE**

***Paper by E. W. Kettering  
Chief Engineer  
Electro-Motive Division  
General Motors Corporation***

***Presented before  
American Society of Mechanical Engineers  
Atlantic City, New Jersey  
November 29, 1951***

## TABLE OF CONTENTS

	Page
History	1
Gasoline Engines	2
Early Diesels	2
Model 201	7
Model 201A	8
Model 567 Basic Design	18
Performance Comparisons	20
Component Part Development - 567	22
Pistons	22
Connecting Rods and Bearings	30
Cylinder Liners - Seals - Gaskets	34
Cylinder Head and Valve Gear	38
Injector	45
Blowers	46
Lube Oil Pumps	47
Water Pumps	49
Camshaft and Blower Drive Gear Train	50
Crankshaft and Main Bearings	52
Crankcase	55
Future Developments	61
Summary	66
General Specifications	71

## THE HISTORY AND DEVELOPMENT OF THE 567 SERIES GENERAL MOTORS LOCOMOTIVE ENGINE

Before going into the details of the 567 design it would be well to cover some of the background and know where Electro-Motive stood when this design program was started. Electro-Motive had considerable background in the use of internal combustion engines in railroad service. The first EMD rail car was built in 1923. This car was powered by a 4 cycle gasoline engine rated at 175 horsepower at 1050 RPM (Fig. 1).

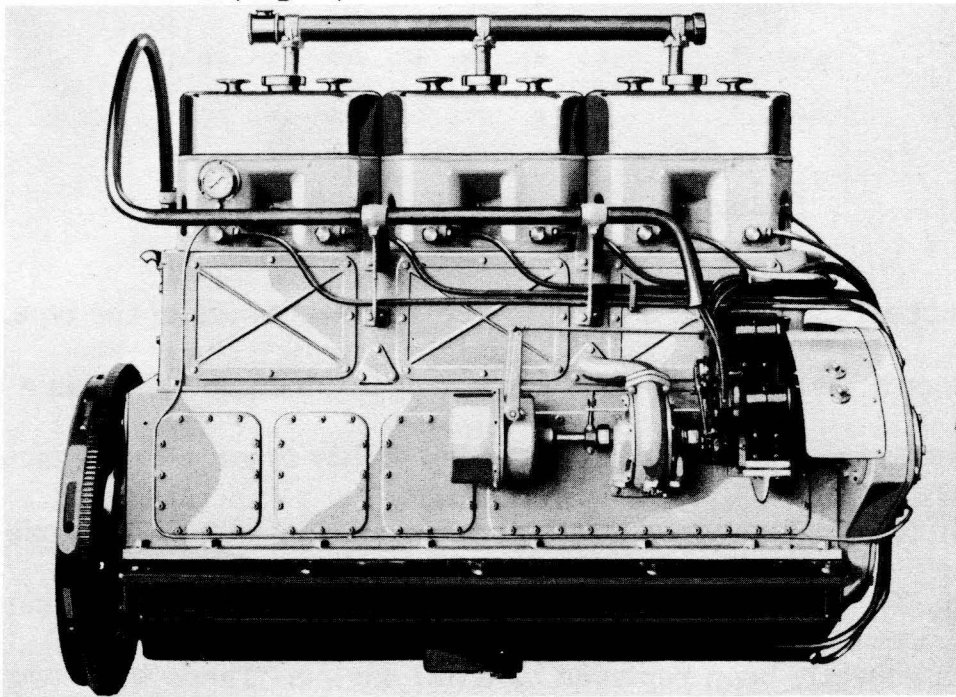

(Fig. 1) Winton Model 106 Gasoline Engine

This engine was designed and built by the Winton Engine Company, Cleveland, Ohio, primarily for marine service but was modified for use in rail cars. This engine generally proved to be successful and many minor improvements were incorporated during the time it was used.

As more rail cars came into use the inevitable railroad cry was heard, in fact within a year after the first rail car was put in service we heard the cry for more horsepower. This started a long series of engine designs leading up to the 567 series. Up until 1930 the engines used in railroad service were spark ignition burning low grade gasoline or distillate. This series is shown briefly in Figure 2.

ELECTRO-MOTIVE RAILCAR ENGINES									
MODEL	MFR.	FUEL	CYL.	BORE	STROKE	R.P.M.	HP-NOM.	WT-LB.	LB-HP.
106	WINTON	GASOLINE	6	7	8	1050	175	4270	244
106A	"	"	6	7 $\frac{1}{4}$	8	1050	220	4270	194
120	"	"	6	7 $\frac{1}{2}$	8 $\frac{1}{2}$	1050	275	4520	164
6-146	"	"	6	8	10	900	300	7814	261
8-148	"	"	8	8	10	900	400	9995	249
12-194	"	DISTILLATE	12	9	12	900	900	18000	200

(Fig. 2)

These were not all the models used but were representative of the type. Note the last engine shown. It was a very large spark ignition engine and was a definite attempt to develop enough horsepower and durability to get the rail motor car out of the Branch Line class and put it on the Main Line. Only one of these engines was built (Fig. 3). It was in operation with reasonable success for roughly twenty years and has recently been replaced by a 567 engine. There were two main factors which probably caused this engine to be dropped. Gasoline prices were steadily going up and in 1930 there was very little money being spent by railroads on purchasing motor cars. There was also another reason. In June, 1930, General Motors bought the Winton Engine Company to have an outlet in the Diesel field. After its purchase, General Motors found that Winton's principal customer was Electro-Motive so a further study was made, and in September, 1930, they bought

the Electro-Motive Company. What with the confusion and the depression, the cost of gasoline and the optimistic talk of the General Motors Research people of the possibilities of building a good lightweight 2 cycle Diesel engine, the year 1930 must have been most confusing for both Winton and EMD.

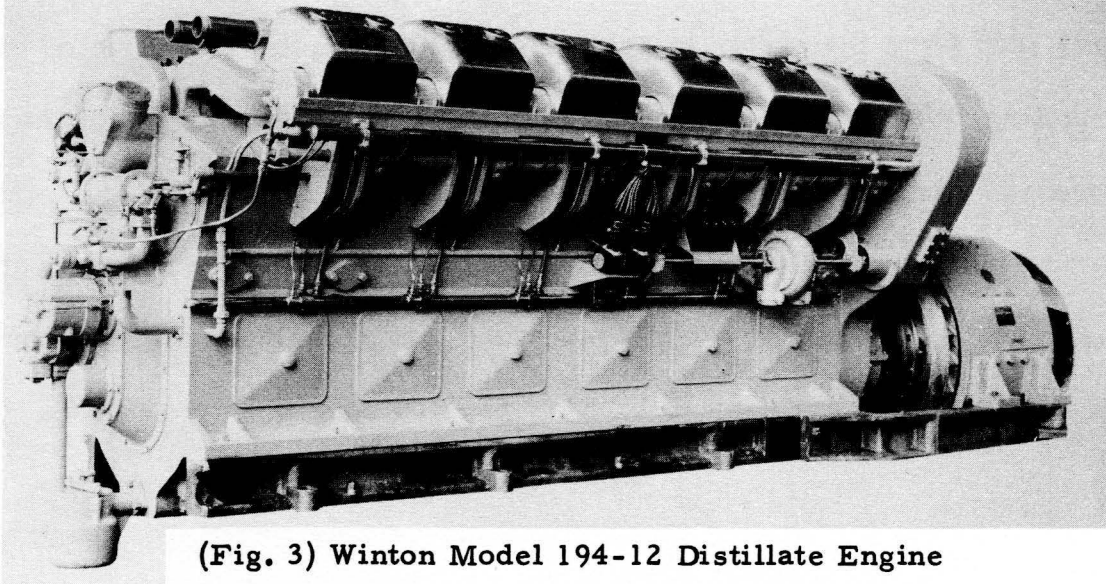

(Fig. 3) Winton Model 194-12 Distillate Engine

By the time Electro-Motive had been purchased a tentative cooperative experimental program had been laid out between the newly created Winton Experimental Engineering Department and General Motors Research. This was the beginning of the development of the 2 cycle Diesel engine and the unit injector. This may sound to you as though there had been some profound thinking on the part of both organizations. It is true General Motors Research had studied the principles in 2 cycle design. They had also surveyed blower design to analyze which type would be the most practical. Winton had built two engines using the unit injector principle, although its injectors were mechanically much different than the present type. I came to work at Cleveland the same September mentioned above. I was a very green kid just out of school but it was not long before I found I knew about as much as anybody there did about 2 cycle engines and unit injectors. The general program agreed on at that time was for Winton to design and build two 1-cylinder

test engines with about an 8" bore and 10" stroke using components of a successful multi-cylinder design. The engine was to be designed so that it could be converted into a 2 cycle type. The basic design was similar to small single cylinder test engines used by General Motors. It had a three-throw crankshaft. The two end throws were 180° from the center or main crankpin on which were mounted two small connecting rods and dummy pistons to balance the inertia forces of the main power piston and connecting rod. The cylinder head, valve gear, camshaft, piston and rod were used from a 16 cylinder marine engine. This design had two camshafts, one in the crankcase for 4 cycle operation and one mounted next to the cylinder head driven by a tower shaft to be used when running 2 cycle (Fig. 4).

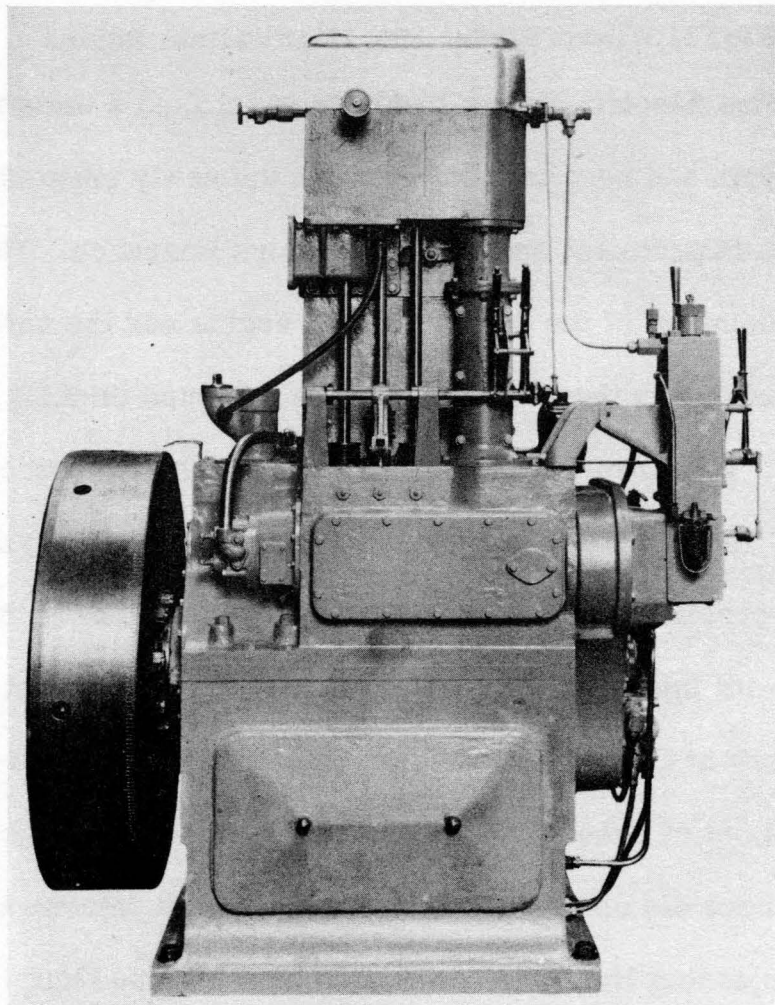

**(Fig. 4) Original GM 2 Cycle 1 Cylinder Test Engine**

One of these test engines was sent to Detroit to be used for investigating the 2 cycle problems and the second was used by Winton to develop the unit injector. Both engines were run 4 cycle to get a base line then General Motors Research converted theirs to 2 cycle. Winton continued to run 4 cycle on injector work. As soon as the engine was run on the 2 cycle principle, many deficiencies were found. The camshaft and valve gear had to be redesigned as they would not operate at the speeds required on a 2 cycle engine. Winton found the cylinder head had to be redesigned to allow more room for the unit type injector. In short, before Winton had a chance to convert their engine to 2 cycle, so many mechanical troubles had developed at Research that it was decided to make a completely new design.

Using the experience at hand, a new single cylinder test engine was designed, incorporating many of the ideas and changes to correct mechanical troubles which had been encountered in the first design. The second design was only 2 cycle so it could be considerably simplified (Fig. 5).

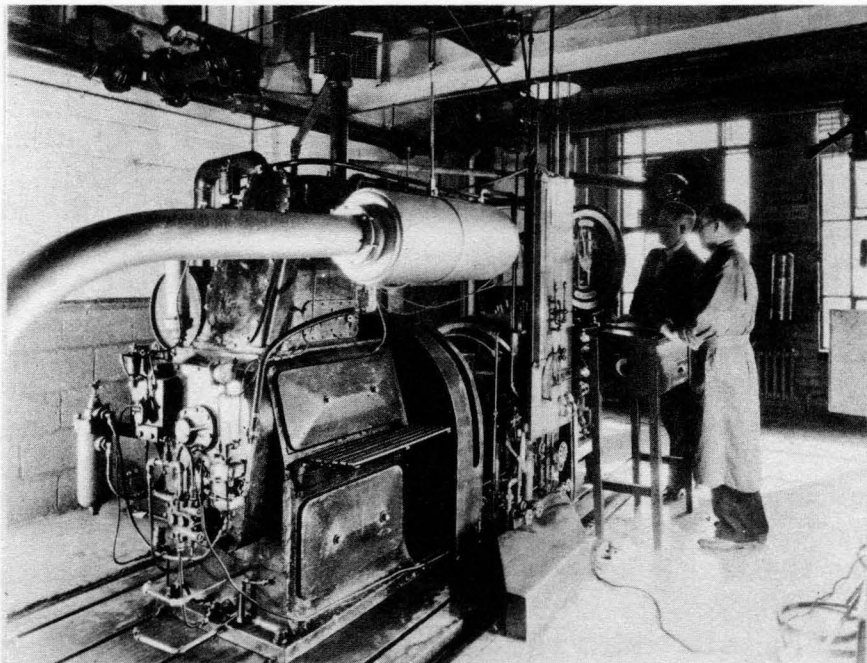

(Fig. 5) GM Research 2 Cycle 8 x 10 Engine

The basic 2 cycle engine design established at this time has been successfully used in the full line of Diesel engines built by General Motors and therefore has been applied to a great many of the Diesel engines in use in the world today. These have all been direct injection, uni-flow engines with air admitted under pressure supplied by the blower to the cylinder through ports in the cylinder liner with the piston acting as the intake valve. The exhaust valves in the cylinder head are open when the intake ports are open, allowing the fresh charge of air to sweep out the combustion products of the previous cycle. Valves and ports are closed at approximately the same time and the fresh air charge is compressed. Slightly before the top of the piston travel, fuel is admitted with very exact control by the unit injector and combustion occurs very near top center to allow full use of the developed power.

This second engine turned out to be very good mechanically and proved to be a good workbench on which to work out bugs on the 2 cycle and unit injector problems. The injector had been running fairly well so Winton pitched in and helped on many of the 2 cycle problems, such as testing various intake port angles, intake port and exhaust valve timing, charging pressures, excess air, etc. Many changes were made to increase the breathing capacity, improve valve gear, better injection characteristics and timing until the general performance from a combustion standpoint was looking very good.

As the output was increased new troubles popped up and most of the old ones returned. The injector was proven in theory but very little work had been expended on manufacturing problems or the proper and best materials to use. General Motors Research was in a much better position for this type of work, and therefore took over the unit injector project. The problems were becoming more and more Winton's and less General Motors Research because it now looked like an 8 cylinder engine could be built with a rating of 600 horsepower.



The best 4 cycle, 8 cylinder of this bore and stroke was then rated 400 HP, so it appeared that we had a fair edge over the 4 cycle, and the 8 cylinder design was started. General Motors Research, having made a considerable study of blower design, took over this problem and developed the Roots type 3 lobed helical aluminum blower which has been most successful, and was the prototype of the 567 engine blowers. They also undertook development of the piston pin and bearing which had caused considerable trouble. Their work with the single cylinder continued more on the theoretical problems of pistons, air flow, valve gear, etc., and most of Winton's time was put in on the multi-cylinder design.

Please do not get the idea we thought the problems were licked even at 75 HP per cylinder, but we did think we would know enough by the time the 8 cylinder was designed and built to make it satisfactory at this rating. This was the most optimistic overstatement up to this time. To make matters worse, before the 8 cylinder had been run, some brave soul decided it would be great to build two engines and have them furnish power for the General Motors Building at the 1933 Chicago Worlds Fair. The U.S. Navy had been following this 2 cycle development work and had given Winton a design contract for a "V" 12 cylinder engine which was designed concurrently with the 8 cylinder. These engines were known as the Model 201 and had a fabricated steel crankcase, one of the first in this country. A very unconventional cylinder head retainer design with a round head similar to the 567 was used. This was fastened in an 8 cylinder long aluminum casting. This casting carried the overhead camshaft, as well as the passages for cooling water, fuel and lubricating oil. When the engine was first started these three liquids came out almost every place except where they should. After resorting to doping, peening, and everything in the book, the first engine was finally made to run. Immediately a new cylinder head retainer design in cast iron was started. After

surprisingly few early troubles the 8 cylinder engine was up to 600 HP and was doing it with a clean exhaust (well, almost clean) and with better fuel consumption than the 8 cylinder 8x10 4 cycle. In general the performance was very good. Not much running was done before this engine and its mate had to be sent to Chicago

(Fig. 6).

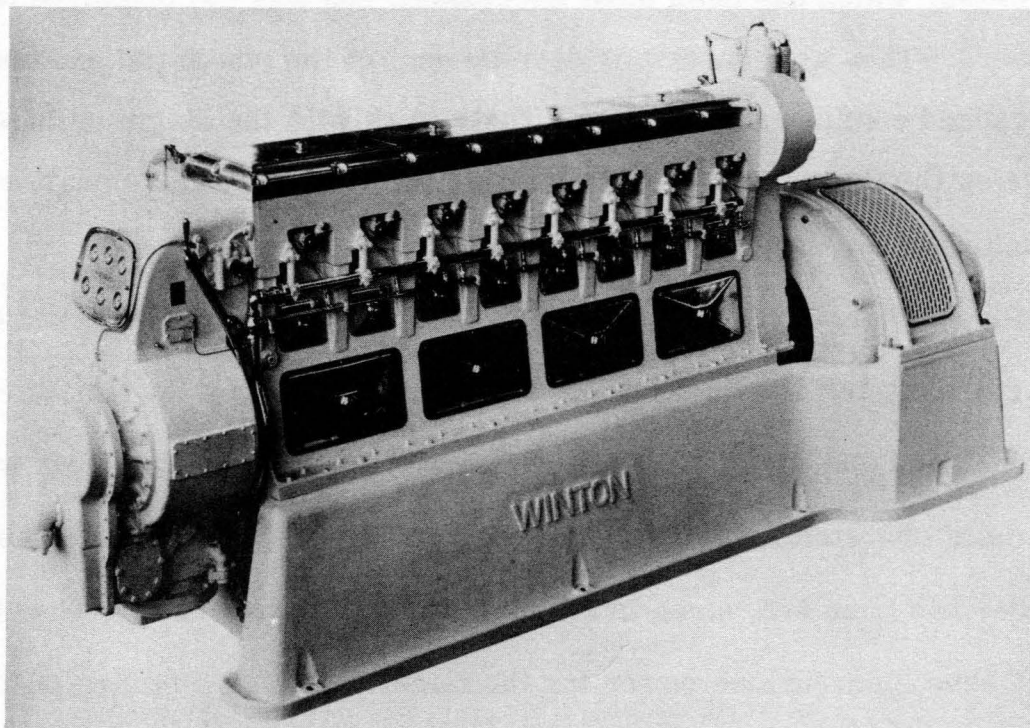

(Fig. 6) Model 8-201 World's Fair Engine

From here on the flow of rush parts from Cleveland and Detroit to Chicago was fearful and wonderful. The boys worked all night and hoped the engines would run all the next day. It was no fun but we learned fast and a new design study was soon under way at Winton. To mention the parts with which we had trouble in Chicago would take far too much time. Let it suffice to say that I do not remember any trouble with the dip stick.

The redesign was quite well under way when a very nervy railroad president, with considerable help from both General Motors and Electro-Motive decided his new three car Zephyr should be powered by Diesel. The 8-201A, as the redesign was designated, was the only engine that could be considered, and because it was still on paper it was really a wonderful engine. As soon as the power

assemblies were designed for the 201A a new single cylinder test engine was designed using these parts. Although the first engine was to be a straight 8 for the Zephyr, the design of a "V" 16 cylinder for the Navy was carried on at the same time. Many of the 201A shortcomings in railroad service resulted from design limitations imposed by the Navy.

The 201A design when finished bore little resemblance to its predecessor, the 201. Many of the mechanical faults of the 201 were corrected and it was considerably improved from a manufacturing standpoint. The 1 cylinder 201A engine was a fine development tool, and an enormous amount of basic development work was done on this model (Fig. 7). At one time Winton was using five single cylinder engines and one 8 cylinder engine for basic development work.

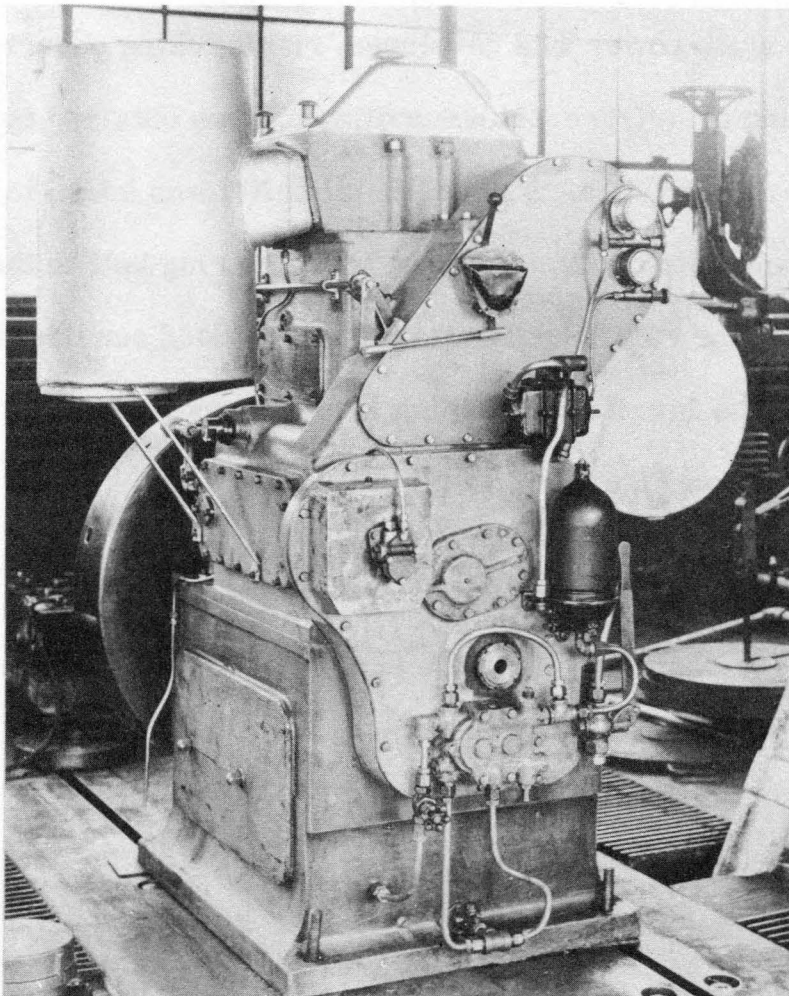

(Fig. 7) 201A Single Cylinder Engine

It may be of interest to some of you to go into more detail on how the 1 cylinder engines were used. One of the first parts to show a weakness was the piston. The original piston was a conventionally designed aluminum casting with 6 compression rings above the pin and two oil control rings below (Fig. 8).

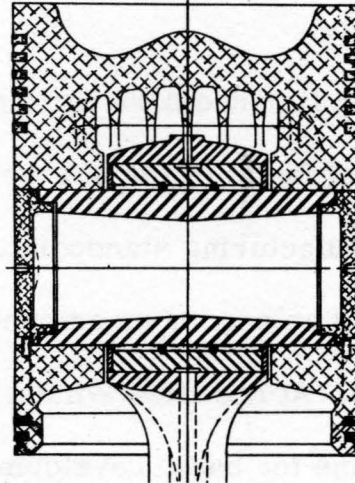

(Fig. 8)

If very much power was developed, ring sticking occurred, causing blow-by and scoring or seizure. More cooling oil was obtained by modifying the connecting rod bearing groove. A sheet metal baffle was added to retain more oil within the piston and help conduct the heat from the ring belt to the skirt. This definitely improved the ring sticking condition but added considerably to the oil control problem. The lower compression ring was converted into an oil ring. This piston is shown on Figure 9.

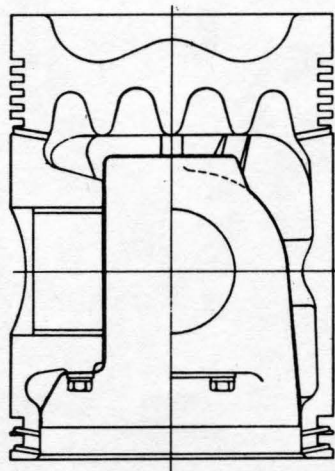

(Fig. 9)

Many ring combinations were tried but very little was accomplished on the ring sticking problem. It was obvious that if the output were to be increased, the piston was the weak link. By this time considerable piston trouble was being reported by Electro-Motive on both the City of Portland and the Burlington Zephyrs, certainly much more than we had expected. General Motors Research had been studying the basic piston problems and had made some temperature measurements at the top ring on the top land, the center of the piston and the top of the skirt. They had also increased the amount of cooling oil to an extreme and found very little additional cooling resulted on conventional aluminum design. One of the bits of information obtained from these tests was that approximately 70% of the total heat dissipated from the piston is conducted through the ring belt into the liner, and of this 70% almost 90% was apparently handled by the top ring.

A new and much more elaborate piston development program was started. This was early in 1934 and before the end of the year the five single cylinder engines were working wholly on the piston problem. This project had three basic parts; first, to continue with the development of the conventional design to try to get the best possible performance at 75 HP per cylinder; second, to carry on two new development ideas, one known as the heat dam aluminum design; and third, a completely new design in high strength cast iron. Figure 10 shows two of

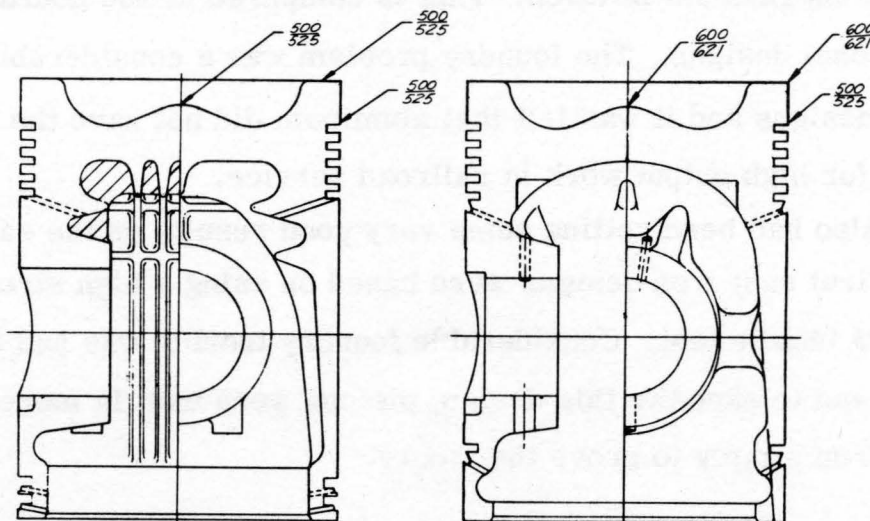

(Fig. 10)

the most successful of the conventional aluminum designs tested with the temperatures recorded at the three basic points above the top ring, the top land, and the center. There was later a third modification in which this design was made into a forging, which added to its service life considerably. This is the piston still being used in this engine.

In the heat dam design an attempt was made to cast a thermal barrier behind the top ring to equalize the flow of heat to the ring belt and force the lower rings to do more of this work. Of this general type of piston seven designs were run. Plenty of trouble was encountered. The most successful one was design #3 shown in Figure 11.

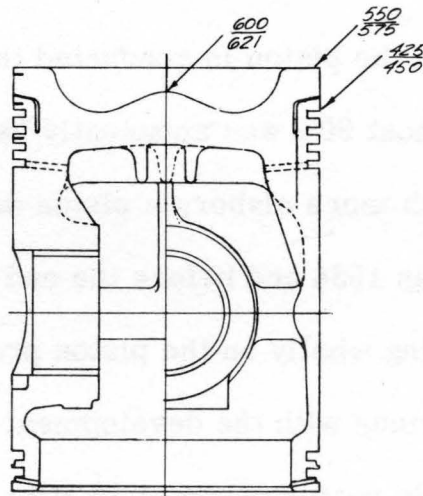

(Fig. 11)

This piston was run over 1300 hours at 82-1/2 HP per cylinder with no ring sticking or mechanical failures. This is compared to 100 hours at 82-1/2 HP on the conventional designs. The foundry problem was a considerable headache in many of these designs and it was felt that aluminum did not have the mechanical life necessary for high output work in railroad service.

We also had been getting some very good results on the early cast iron designs. The first cast iron designs were based on using a high strength cast iron of about 75,000# tensile test. Considerable foundry trouble was had in getting a sound casting, and to expedite this design, pistons were cast in more conventional strength grey iron simply to prove the theory.

Much to our surprise we found the piston with minor modifications ran very successfully in the lower strength alloys. Figure #12 shows one of the better cast iron designs run in these engines. In fact, some of you might see considerable resemblance between the first 567 one-piece pistons and this one.

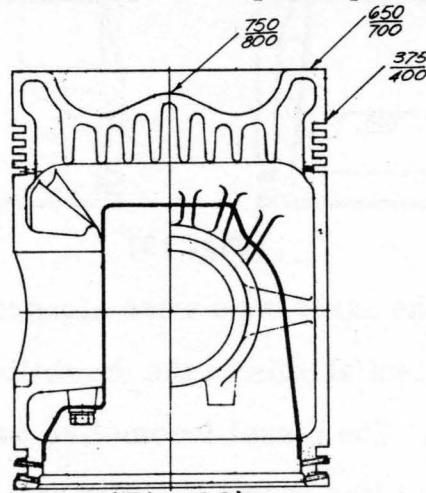

(Fig. 12)

Whereas this paper is on the development of the 567 engine and not on pistons, it seems appropriate to at least explain why this cast iron piston was never used in the 201A engine. The one thing we knew for sure was, with the heat dam type piston both in aluminum and in cast iron, the heat must be removed with cooling oil. We had taken many liberties with the 1 cylinder engines to increase the cooling oil to the pistons, resorting to such things as extreme grooving of the connecting rod, running very close clearances to reduce leakage, and extremely high oil pressures. None of these were practical on the 201A design for obvious reasons. We were primarily interested in learning the principles to develop the very best piston we could. Figure #13 shows two of the many unconventional pistons which were unsuccessfully tried. More and more 201As were being put into railroad service and more and more troubles came to light. The usual confusion existed in the early days, such as the engine manufacturer stating the cylinder head trouble was caused by an inadequate cooling system, and the locomotive manufacturer saying the cylinder head was not satisfactory for railroad use, etc.

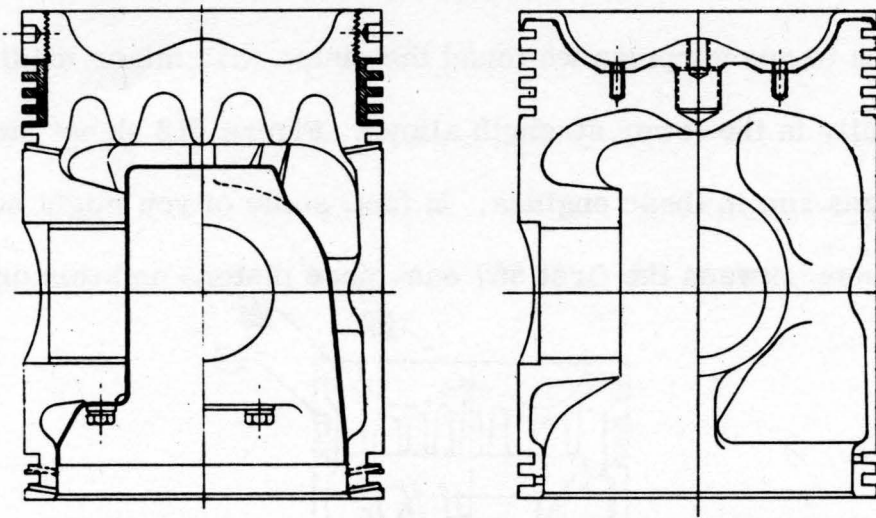

(Fig. 13)

In time most of the early bugs were cleaned up, but it was becoming more evident that to make a substantial gain in the durability of the 201A engine a major redesign would be in order. The diesel locomotive was rapidly proving itself and to the more optimistic it looked like it was going to be a good business, so it was decided that the engine would be redesigned for railroad use only. The design would not be handicapped by requirements for marine, Navy, or stationary application. Most of the Winton experimental design group moved to Detroit where the redesign was to be made. After settling in Detroit we took a large piece of paper and on one side wrote down all of the troubles which were known in the 201A engine at that time. On the other side we were going to write down parts of the engine which had been satisfactory. These items were based on the four years experience in the field and the test work at Winton and General Motors Research. It did not take long to fill in one side of the sheet. In fact, the more we looked into what we could salvage of the 201A design to correct all of these troubles the more apparent it was that we should start with a clean piece of paper and forget the 201A. Of course, it is much more fun to start fresh than to try to correct troubles in an old design even though you know you are heading into new troubles. We felt at that time that although we could talk a little 2 cycle design, we spoke with a very heavy 4 cycle accent. We did believe we could understand what a 2 cycle engine was trying to tell us, so with the optimism of youth we barged into the design that ultimately turned out to be the 567.



The 201A "V" type engine was studied both from a manufacturing viewpoint and an overall cost of operation. It was decided, after reviewing the faults of the 201A, that this new design was necessary, the major reasons being:

1. It was possible to better utilize the space requirements using a slightly larger and therefore higher-powered engine than the 201A, the cylinder size being 8-1/2 bore by 10 inch stroke instead of the 8x10 on the 201A, with a slight increase in speed of 800 RPM as compared with 750. The name of the new engine, Model 567, is indicative of the displacement of the new cylinder, 567 cubic inches.
2. The complicated structure of a 201A crankcase necessarily made the engine expensive, resulting in a high selling price to the customer. A more simplified crankcase structure therefore was necessary. Also, since the 201A crankcase was not sufficiently rugged to withstand railroad service, it was necessary to redesign for strength.
3. The life of pistons, heads, cylinder liners, connecting rods and bearings, crankshafts and bearings on the 201A was too short, which caused higher maintenance cost of the engine. Because of crankcase limitations as well as overall engine size, it was not possible to get much improvement in life on these parts.
4. It was necessary to eliminate, wherever possible, all serration or spline drives as well as to design an overspeed trip which was independent of injector control. The camshaft should be overhead in order to eliminate push rods and simplify maintenance.

It may seem that I am unnecessarily running down the 201A engine.

Whereas we believed this engine was not good enough for railroad service, - in all due respect it should be said that it was good enough to prove the Diesel locomotive and to thoroughly launch the revolution of American railroad operation.

As indicated above, it was decided that the new engine should be physically as large as possible to fit into the carbody structure of the locomotive, still keeping in mind, however, that the engine had to be maintained. The pistons, cylinder heads, cylinder liners, connecting rods etc. should be small and light enough to be handled within a locomotive without the use of mechanical lifting devices, and the scavenging blowers, water pumps, oil pumps, governor etc. should be readily accessible for removal within the locomotive. It should have ease of inspection of pistons, liners, etc. as well as easy removal of all wearing parts.

It was readily apparent that a relatively narrow "V" type 2 cycle engine would be the most compact to fill the requirements for a locomotive engine. The original plans called for 8 and 12 cylinder engines with a later possibility of 6 and 16 cylinder models. One of the early difficult problems was calculation of the torsional characteristics in the crankshaft, and the overall balance of each of the four engines plus the development of a firing order which would give the best conditions in each engine. This analysis was adequate as only one harmonic balancer is necessary for all engines except the 6 cylinder which does not need a balancer.

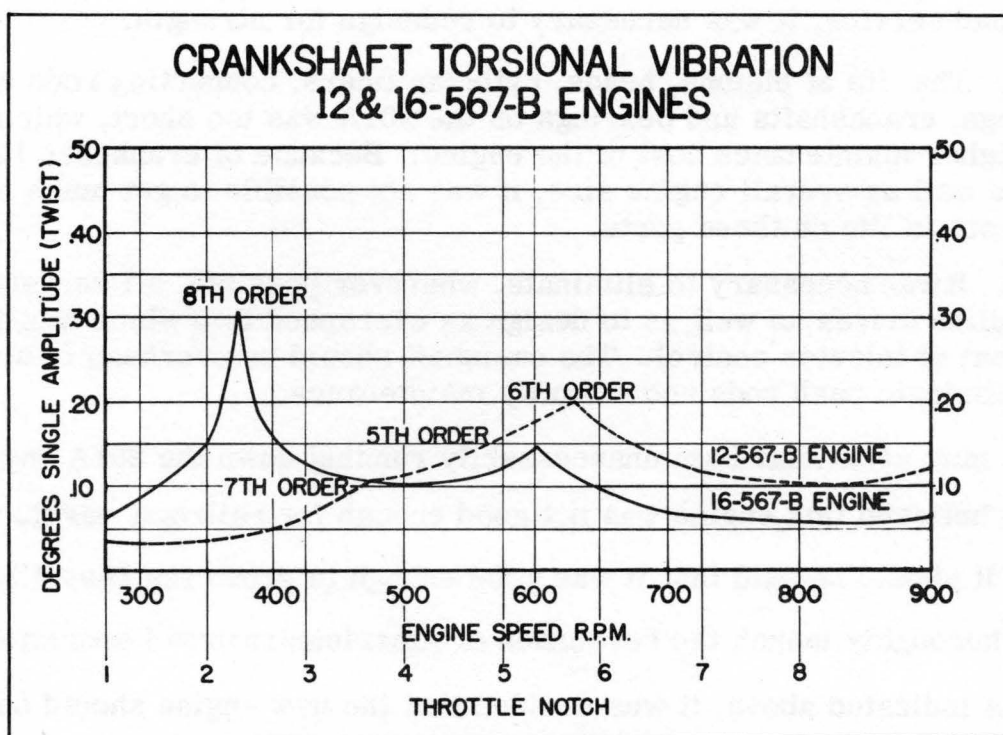

(Fig. 14)

Figure #14 indicates the crankshaft torsional vibration throughout the operating range for a 12 and 16 cylinder engine. The degree of torsional vibration is not sufficient to cause shaft, bearing or gear train difficulties. It can also be noted that the maximum amplitude of torsional vibration does not occur at any governed speed. It is of interest to note that the maximum order of vibration for each engine (number of twists per crankshaft revolution) is the same as the number of crankpins.

The full line of engines was designed with the same general arrangement, revising basically only the length of crankshaft and crankcase to accommodate the required number of cylinders. It appeared that the most satisfactory method of having the engine accessories such as pumps, governor, etc. easily maintained would be to drive them through a gear train at the forward end of the engine, that is, opposite the power take-off end. Having the location of the pumps all at one end of the engine, called the accessory drive end, fitted very well into locomotive installation. A leaf spring flexible drive gear mounted on the crankshaft was used to eliminate all crankshaft torsional vibration from the gear train.

By using either one or two blowers for an 8 or 12 cylinder engine respectively and mounting them above the main generator, it was possible to shorten the overall length of the engine and generator installation. This was one of the main original objectives. The blowers as well as the camshafts were driven at the power take-off end of the engine by another gear train.

It was very important that all accessories be designed in such a way that at least the tooling could be common for all. It was for this basic reason that the oil pumps were designed alike except for pump gear length. The water pumps were designed so that either one or two pumps could be used. The blower design was based on using two blowers for the 12 cylinder, the same two blowers for the 16 with increased speed, and one blower for the 6 and 8. Also the accessory end housings were identical, and by having the drive gears mounted directly on the accessories, interchangeability as well as simple tooling could be accomplished. The camshaft was designed in sections to allow minimum tooling and ease of replacement. The crankshafts were all identical with the exception of length, allowing the use of the same bearings.

This same philosophy in general was used throughout the design. Because of the prospect of reasonably complete tooling, much more effort was put on this design in an endeavor to simplify machining and eliminate as much unnecessary handwork as possible.

In order to develop power assemblies of the multi-cylinder engine as well as get more background on the combustion characteristics of the engine than it had been possible to work out on the single cylinder General Motors Research engine, we built one 2 cylinder 45° "V" 567 engine (See Fig. 15).

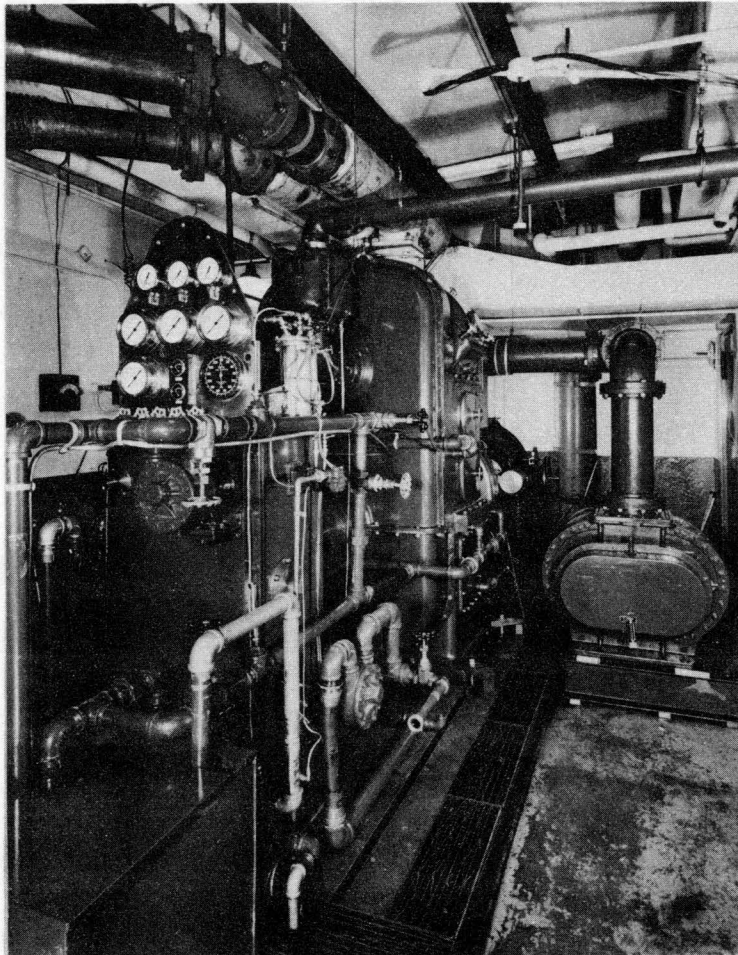

(Fig. 15 ) Original 2-567 Test Engine

This engine was used to study pistons, rings, and their relation to cylinder liners; piston pins and their related bushings; connecting rods and connecting rod bearing design. To digress for a moment on this subject, whereas the multi-cylinder engines had been laid out with a fork and blade type connecting rod, we had no idea how to make one work. Since rod and bearing development alone took so much time, it was necessary that we build a second 2 cylinder engine in order to study the piston, liner, head, and combustion.

These two cylinder engines were made as nearly as possible to duplicate multi-cylinder engine parts of which we were able to exactly duplicate crankshaft connecting rod, wrist pin, piston, piston rings, cylinder liner, cylinder head valve gear and camshaft. The remainder of the parts necessary to make the engine run were not common to the multi-cylinder engines. We made an attempt, however, and were able to develop the intake air distribution (combustion characteristics and exhaust systems) somewhere near that which was produced at a later date on the multi-cylinder engines. This was vital because 2 cycle engines are extremely sensitive to changes affecting breathing.

With these basic considerations in mind, the complete line of Model 567 engines were started in the early Fall of 1936. As the design progressed the more detailed components of the engine were developed and can best be described individually.

However, before developing the background of the various engine components, I would like to tell you what the performance characteristics of our engine are. The new railroad engines were rated at 800 RPM and 80 B.M.E.P. and put in production in 1938. Our 16 cylinder engine was installed in 1350 HP freight units and two 12 cylinder engines in 2000 HP passenger units. Based on field experience we felt the engine rating could be increased, so in 1947 the B.M.E.P. was raised to 92 or 1500 HP on a 16 cylinder engine. Engines at the increased rating are installed in 1500 HP freight units and 2250 HP passenger units. In 1948 a new cooling system was designed for the 12 cylinder switcher, allowing its rating to be increased to 1200 HP, thus making it the same as the 6 and 8 cylinder. If you take the time to calculate back to horsepower from the B.M.E.P. figures I have given you, you will be ready to tell me the horsepower figures are too high. However, B.M.E.P. is actual engine output at the crankshaft coupling. Locomotive horsepower is our guaranteed horsepower to the generator available for traction and in addition to being a conservative rating, does not include locomotive auxiliary load.

Figure 16 will serve to explain this, indicating total engine horsepower at rated load of 1280 for a guaranteed locomotive horsepower of 1125 and an actual delivered horsepower to the generator of 1210. These data were run at 90° F. ambient.

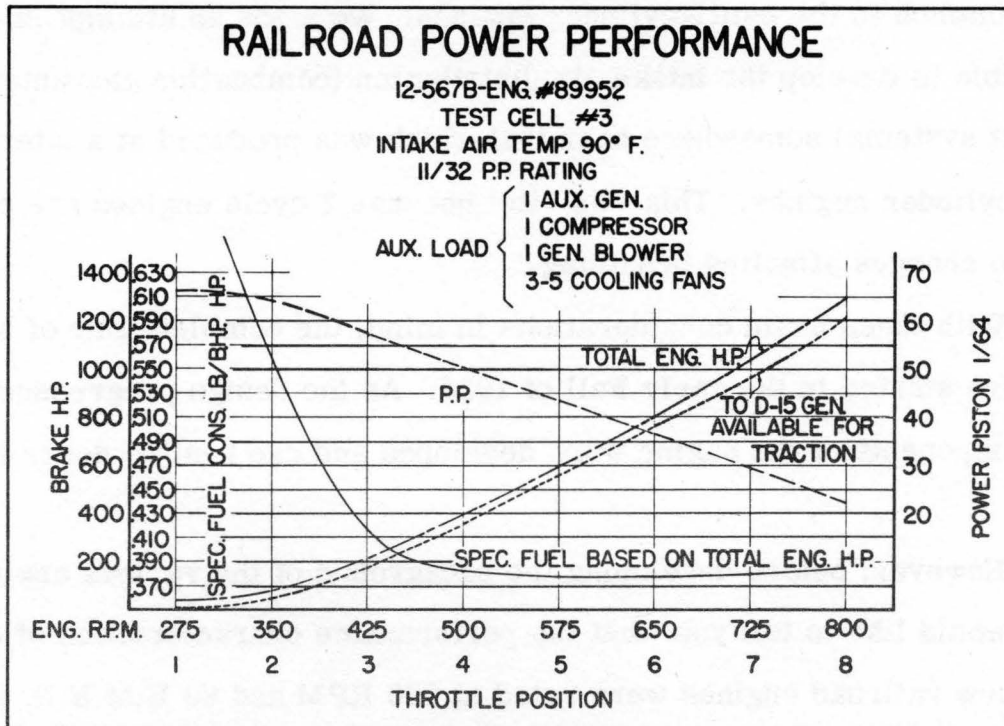

(Fig. 16)

This graph also indicates additional performance characteristics of our engines. Our road locomotive load control regulates the engine to only eight output positions or throttle notches. At each throttle notch the engine operates at a governing speed and fuel input. This latter control in our language is indicated by power piston gap measurement. This graph indicates the pre-determined characteristics of speed and fuel input. The plotted characteristics of output and specific fuel consumption are results and will vary with engine conditions, atmospheric conditions, altitude and fuel B.T.U. value. A paper entitled "Altitude Performance of Electro-Motive 567 Engines Under Railroad Conditions" by Barth, Lyon and Wallis presented before the S.A.E. on November 2-3, 1950, develops the effects of these variables on engine output.

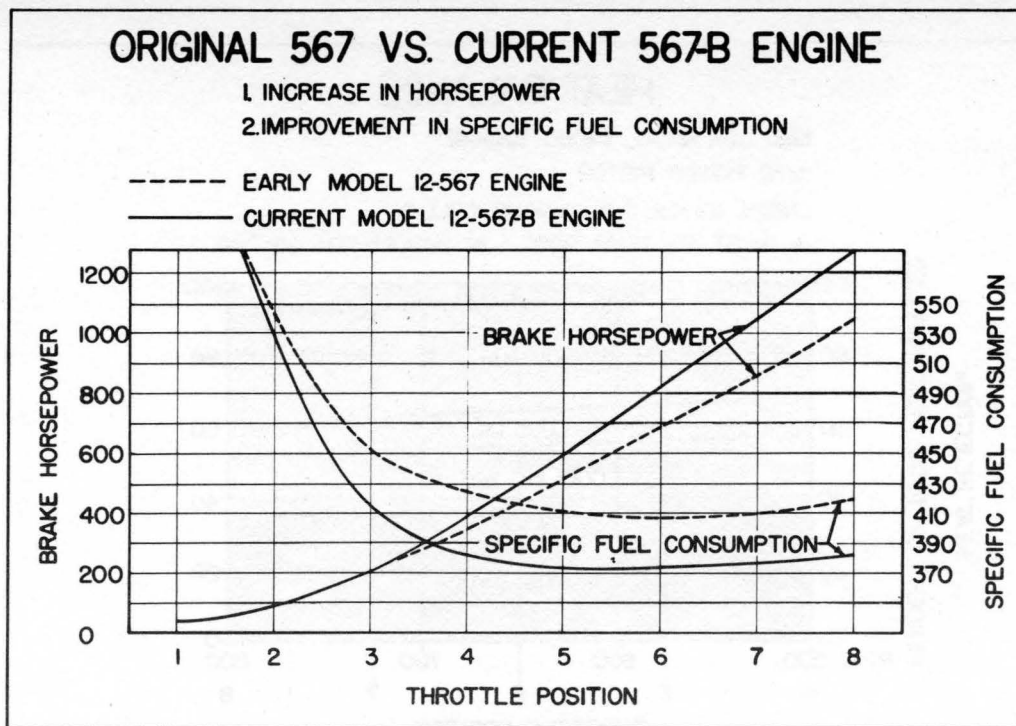

(Fig. 17)

Rated load specific fuel consumption of the engine is .382 pounds per brake horsepower hour. Throughout the upper engine operating range this excellent economy is exhibited. However, this output and economy are a result of engine improvements achieved through the years. Figure 17 compares our original production engines with those manufactured currently. Under rated load conditions output is increased 17% and specific fuel consumption has decreased 9%. The reasons for these improvements will be developed later. It might be well to note here we are making a line of engines not only for Main Line locomotives, but also for Switching service so that we were not only striving for good fuel economy at high power but also good economy at idle and low power conditions for switching service. This has definitely been accomplished. Field results show our switching locomotives to be very low in fuel consumption.

Figure 18 indicates the distribution of energy produced during engine operation as a heat balance. At rated output the brake work utilizes 33-1/2% of the supplied fuel (indicative of thermal efficiency) and normal energy dissipation includes exhaust 31%, cooling water 19% and lubricating oil 7%.

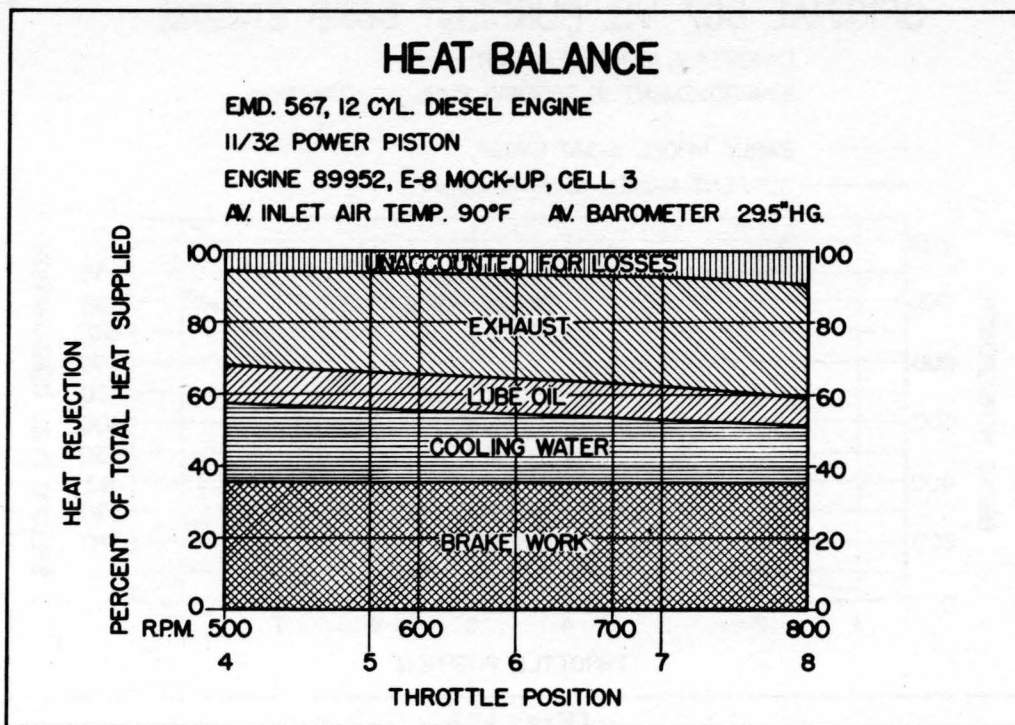

(Fig. 18)

The unaccounted heat loss which is largely radiation, is 9-1/2%. This heat balance data for a 12 cylinder engine is only carried down to the fourth throttle position because the rise in cooling water temperature below this point is so low it cannot be accurately determined.

### PISTONS

From experience with 201A pistons and later 8-1/2 inch pistons made of both aluminum and cast iron, it was written down that cast iron pistons would be used. From data obtained both from the old Winton Laboratory and General Motors Research on single and 2 cylinder 567 engines, it was quite evident that properly oil cooled cast iron pistons could operate at lower temperatures than aluminum pistons. The cast iron was selected because of much higher hot strength, much better ring belt life, as well as excellent skirt bearing properties. From previous test runs on the original 8-1/2x10 inch single cylinder engine it was found that the top ring belt temperature, that is, the temperature above the top ring, could be held to about 330° F. with proper piston cooling. These tests were



readily duplicated on the 2 cylinder 567 engines. This was approximately 150° lower than the aluminum pistons on the 201A engine (Fig. 19).

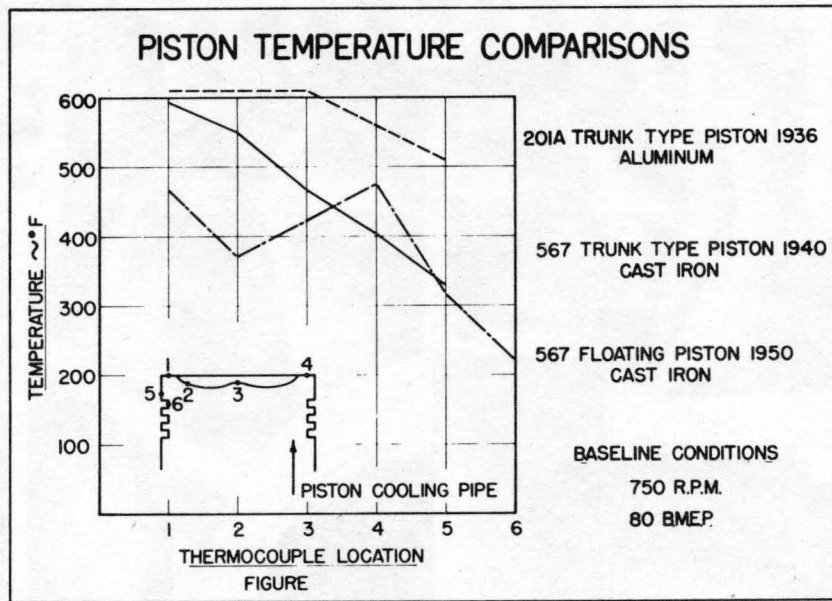

(Fig. 19)

Due to the limitation of data available on older piston designs, this chart shows an 80 B.M.E.P. 750 RPM base line even though this is not the present rating of the 567 railroad engine. The trunk or rib type piston was redesigned subsequent to the piston used in the above illustrated data. A deflector was added to better distribute the jet cooling oil. Although tests were not run after the addition of the deflector, undoubtedly it resulted in lower temperatures at Point I and increase of temperature at Point IV.

With regard to the actual design of the piston it was known that a heat dam above the top ring was necessary in order to maintain relatively low ring belt temperature. This heat dam as illustrated (Fig. 20) restricted the heat to the ring belt, the crown and rim heat being removed by the cooling oil. It was found to be possible by means of jet cooling, that is, directing oil through an orifice aimed to a hole in the piston baffle, to get an adequate supply of oil to properly cool the piston.

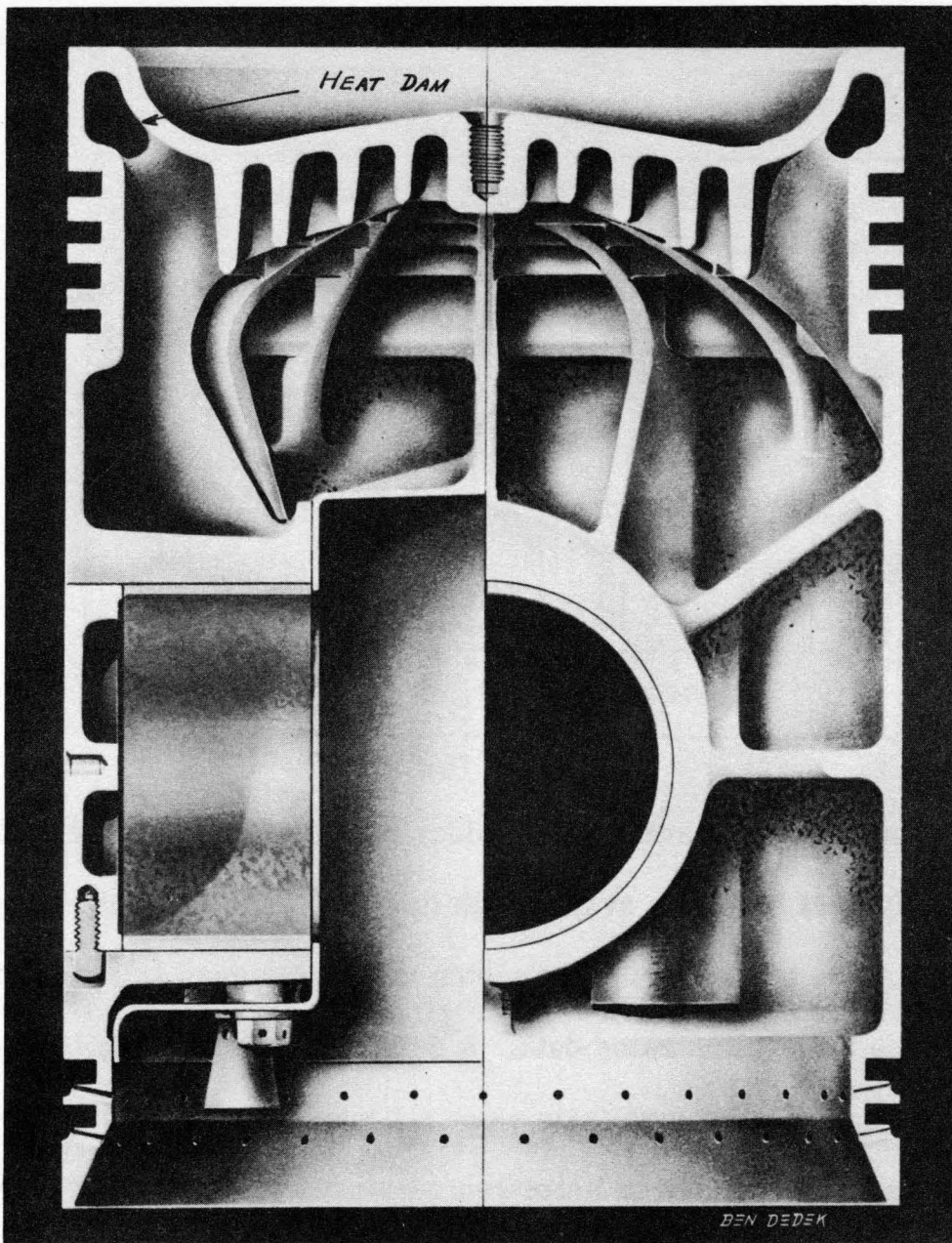

(Fig. 20) First 567 Piston

From temperature checks run on pistons in operation it appeared that approximately 2 to 2-1/2 gallons per minute per piston were sufficient to satisfactorily cool the cast iron piston. In order to add a safety factor to this, the pump was designed and the orifice fixed to pump approximately 3-1/3 gallons per minute per piston. It was not practical because of the connecting rod design as well as connecting rod bearing area to cool the piston by means of a drilled connecting rod.

Most of this testing had been done at equivalent full load on the single cylinder engine and there was considerable discussion as to whether the cooling oil should be in proportion to the B.M.E.P. or torque or whether the cooling oil should be in proportion to the speed. It was finally decided, inasmuch as a railroad engine runs on known power curves, that we should make the system as simple as possible with no control valves by connecting the pump directly to the piston cooling jets. This decision proved sound for railroad application, although some trouble has been experienced when high B.M.E.P.s are run at low engine speeds such as resulted from the poor selection of a propeller in one of our tug-boat applications. Figure 21 illustrates the excess of cooling oil shown on the left-hand side of the chart. The curve on the right illustrates actual operating temperature under railroad conditions. The photographs at the bottom of the chart illustrate the intermittent method used in measuring piston temperatures.

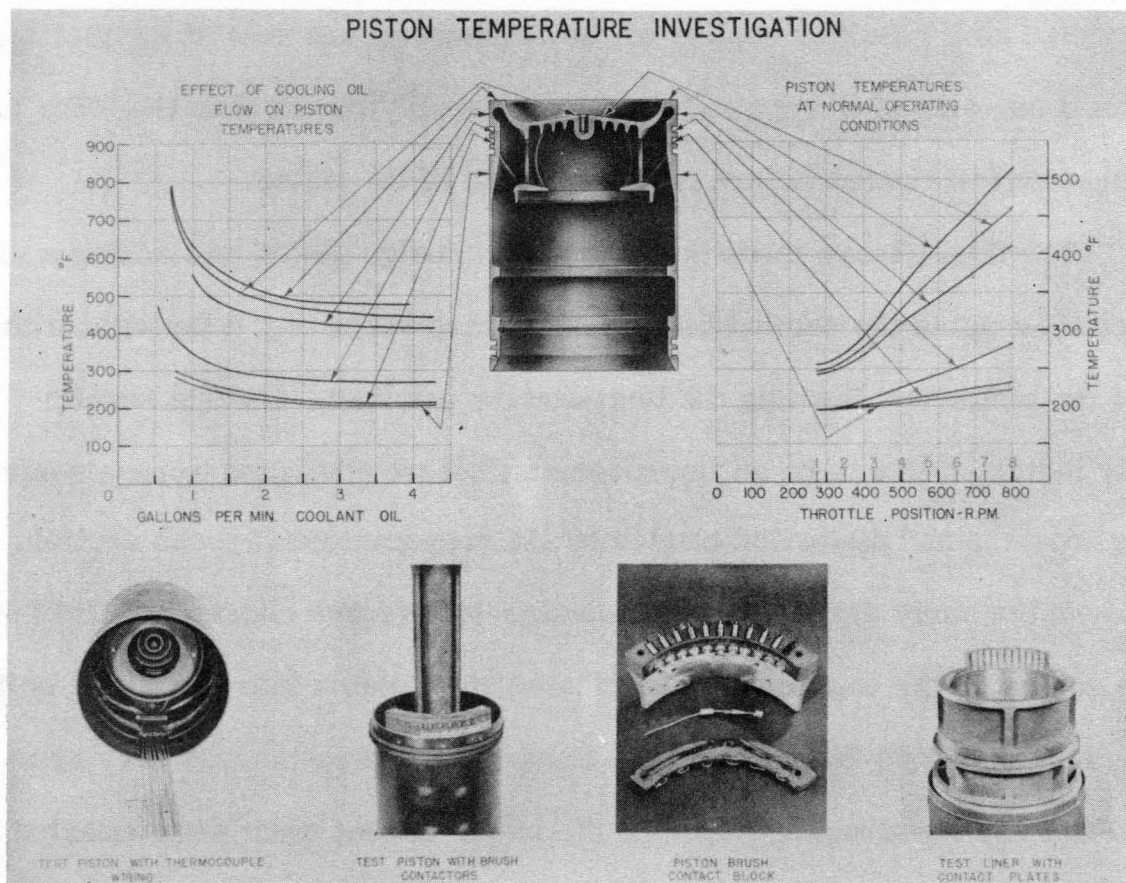

(Fig. 21)

A one piece cast iron piston design was tried first. The same design was later made of malleable iron prior to production of the 567 engine. In production it was found that whereas the one piece piston worked satisfactorily and gave a much better account of itself than the 201A aluminum piston, it was still unsatisfactory from two counts. We had almost succeeded in designing a casting which could not be cast. The piston created a serious foundry problem, a tremendous amount of scrap and premature field failures caused by foundry difficulties. As is common in most strut or rib type pistons where the crown is supported by means of struts or ribs from the wrist pin boss, a bad temperature gradient occurs between the skirt of the piston and inner edges of the ribs, thus causing ring belt cracking. To overcome these two difficulties many designs of one-piece pistons were drawn up and some were made and tested.

As indicated on the previous chart (Fig. 21) considerable thermal stress existed as a result of cooling oil impingement on one side of the piston rim. This caused one side of the crown to run considerably cooler than the other and the thermal stress caused failure on the hot side of the piston.

The first change made on the original design piston was adding a cast-in deflector on which the cooling oil impinged, thus spreading it throughout the crown of the piston and leveling the temperature gradient. Service results definitely indicated this to be an improvement, but we continued to have some cracking troubles and distortion caused by the unsymmetrical cross section.

In the early days of the war Electro-Motive was chosen to build the 184 Pancake engine. This engine had a fabricated steel piston into which was bolted two trunnion-like parts that carried the wrist pin. The piston was very symmetrical and had the advantage that the piston pin bosses were not connected into

the skirt in any way. The appearance of this piston was excellent and all of the test data indicated it was a very successful design. In an attempt to copy the 184 design we ran into some basic difficulties, the principal one being that it was impossible to bolt the trunnions into a design similar to the 184 because the piston cooling jet location was exactly where the bolt should go. A number of waste baskets were filled with drawings trying to design our way out when one day someone made the very simple suggestion, "Why not make the piston pin bosses part of the baffle and pilot it at the top and bottom and retain it with a snap ring?". Calculations indicated that the snap ring would be considerably stronger than any bolts or capscrews which could be applied. To simplify machining, another suggestion was made that the upper pilot be made round rather than using dowels or other methods of location. This meant the piston was free to rotate about the carrier and could be perfectly symmetrical so that upon expansion it would retain its original round shape.

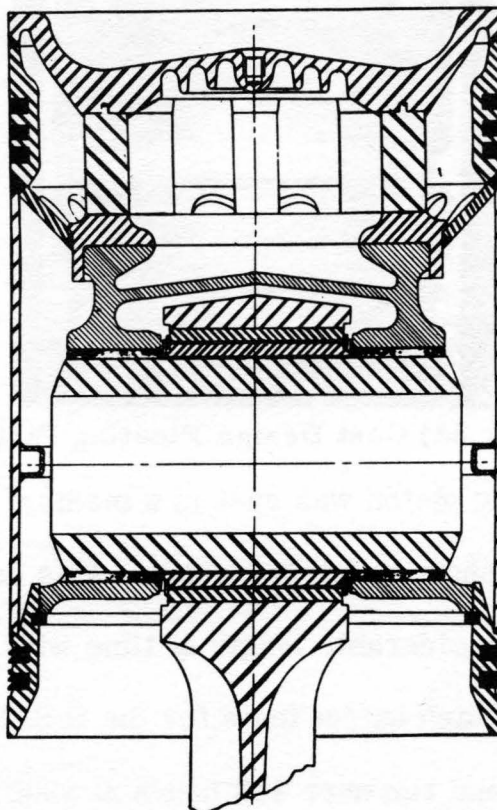

(Fig. 22) Fabricated Design Original 567 Floating Piston

The original design of the floating piston was fabricated steel (Fig. 22). We thought that the elimination of a casting in this vulnerable spot would be an advantage. Because we could not analyze the stresses occurring in the crown and skirt due to thermal stresses as well as the peculiar shape of the crown, it was decided to make a cast design on which it would be easy to change the location of the load carrying members and thus develop the optimum location. On the second steel design the skirt fell off after a short time. This proved we needed the conical member from the platform into the ring belt that was incorporated in the first design.

The cast design had struts tying the platform into the ring belt based on the above experience (Fig. 23).

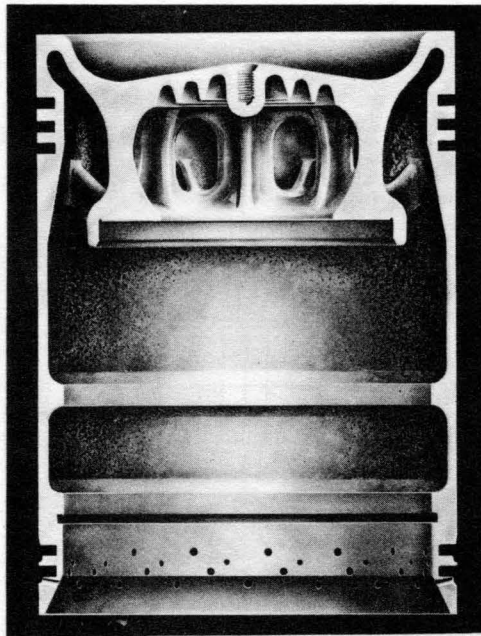

(Fig. 23) Cast Design Floating Piston

The first floating piston was cast in a medium grade cast iron as we wanted the weak points to show up fairly quickly. This design piston was run in a 16 cylinder engine for a considerable length of time with no failures. In fact, when asked to run some special high output tests for the U.S. Navy the engine with these floating pistons was used and run over 400 hours at 2000 B.H.P. and a total of 24

hours at 2250 HP. After this Navy test the pistons were inspected and found to be in excellent condition.

Due to our increased production caused by the Navy's use of this engine in LST boats, the foundry producing the one piece piston was getting into serious difficulties and it appeared that we would be limited in production unless another source was found or we went into production on the floating piston. There being no other source, the decision was rather easy to make, and with minor foundry modifications this piston was proven very satisfactory.

A brief comparison can be drawn as to life of pistons in passenger service. These comparisons must be based on passenger operation as there never were any 201As in any other service than passenger and switcher. The 201A aluminum piston at the very beginning did not run 50,000 miles and the later 201A pistons ran a questionable 100,000 miles in hard service. The average life of the first 567 piston was in the range of 400,000 to 500,000. On one major railroad the average life of the current design two-piece piston is at least one million miles (Fig. 24).

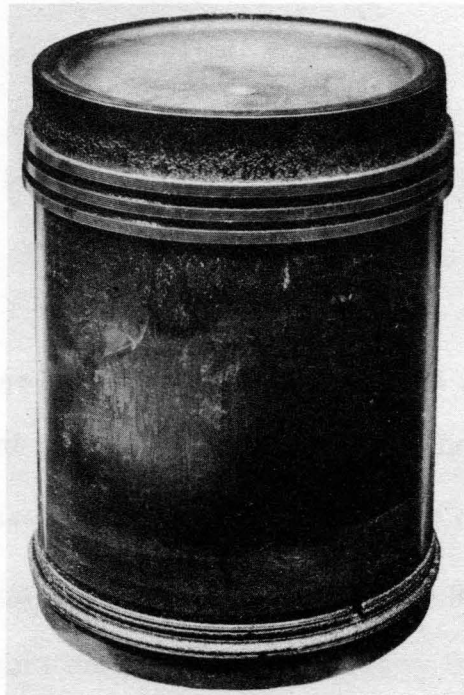

(Fig. 24) Million Mile Piston

## CONNECTING RODS AND BEARINGS

The 567 connecting rod as illustrated in Figure 25 was made of fork and blade design in order that we might make the engine as short as possible, yet with the maximum pin bearing length and make the crankpin as large in diameter as possible. The serrated type basket was used for both of the above reasons, that is, to have the largest connecting rod crankpin bearing possible and still be able to remove the connecting rod through the cylinder bore. Extensive development work on the blade and fork connecting rod and bearing was carried out on the 2 cylinder engine.

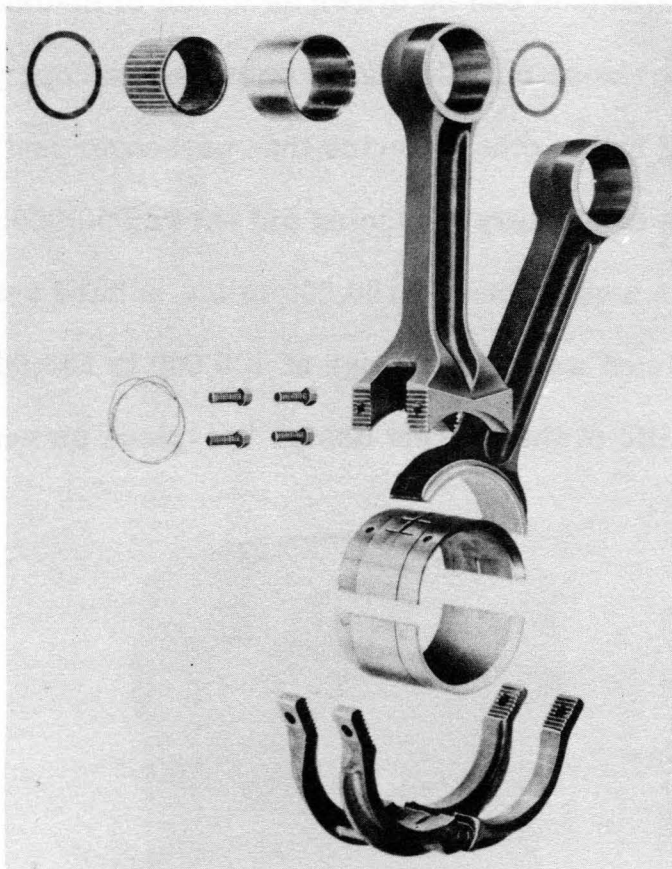

(Fig. 25) Fork and Blade Rod Design

The connecting rod bearing which first went into production (Fig. 26) had copper-lead material on the inside diameter and lead-bronze on the outside diameter. The oiling for the blade rod surface was supplied through connecting holes from a circumferential groove on the crankpin side. There were some



early troubles with this design, namely the copper-lead material was low in fatigue strength and the 360° circumferential groove increased the bearing pressures. The two cylinder engine showed us that a lead-bronze lined bearing on the inside diameter with no groove and only connecting holes through the bearing to lubricate the blade rod surface had eliminated the shelling out of the inside diameter. This change was made and proved to be relatively satisfactory.

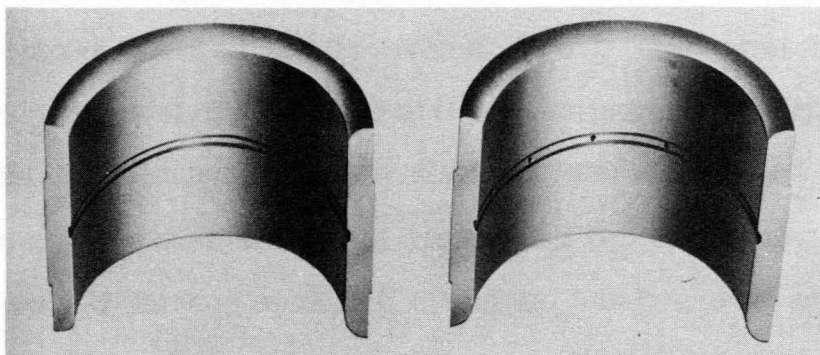

(Fig. 26) First 567 Connecting Rod Bearing

In 1941 a final design change was made (Fig. 27), this being the seventh design in all, in which the oil was fed from the mudpocket at the split line through a tangential hole to a circumferential groove on the outside diameter. To this circumferential groove were connected cross grooves, all grooves being under the blade surface at all times.

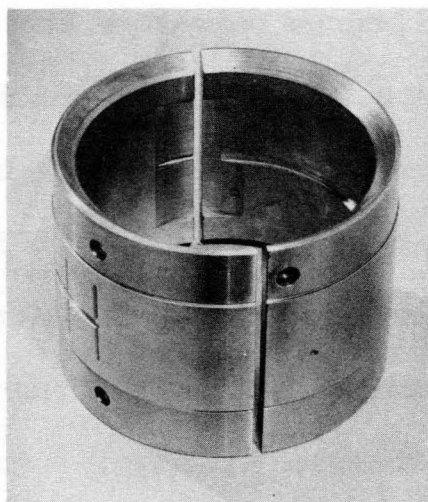

(Fig. 27) Present 567 Connecting Rod Bearing

This design, commonly called the fish-back design from its appearance, has proven to be extremely satisfactory with a life of over eight years on railroads where good lubricating oil maintenance prevails. The inside diameter of this bearing incorporated also a lead-tin overlay for break-in purposes.

During the first two years of production, 1938 to 1940, we were plagued with what was termed as "piston baffle breakage". This baffle was made of sheet metal and bolted into the piston in order to retain cooling oil in the piston. Upon analysis of this field trouble, it was discovered this baffle breakage only occurred on the blade rod side of the engine. At this time the blade rods were being installed in the left bank of the engine. This was done because the bearing load calculated a little lower on the left bank since it was the second cylinder to fire. The rod positions were reversed and the baffle breakage ceased, but we did notice a severe marking of the back of the connecting rod bearing caused by the then symmetrical blade rod surface digging in at one end. Upon analysis we found the blade rod actually leaving the bearing surface when the crankpin was in the horizontal position before top center. This was corrected by the addition of a long toe which retained the rod against centrifugal force so that it no longer dug into the bearing back. The long-toed blade rod placed in the right bank of the engine has given very satisfactory bearing life and remains in current production.

With regard to the top end of the connecting rod, a needle roller bearing was used on the wrist pin and because of previous experience on the 201A the piston pin was made of maximum size in order to obtain the greatest rigidity. A needle bearing design was used for approximately the first two years of production engines. Many years before, in the 201A days, that is in the early days of the 2 cycle engine, pressed in bronze bushings were tried for piston pins. A considerable number of designs were played with and, if I remember correctly, a pin of 4 inch diameter was tried with the most elaborate grooving imaginable. None of the

plain bearing variations was made to run with any success until along about 1940 when somebody who did not know that bronze bearings would not work tried them again in a 567 engine. When this attempt was made the person used two cycle brains instead of four cycle. He simply made the bushing so that it would not be pressed in the rod, but would float in the rod and he gave the bushing a great deal of clearance on both the inside diameter and the outside diameter. This is possible because there is no piston pin reversal in a 2 cycle engine. I am sure that any of the designs originally tried would have worked had they been fitted with 2 cycle rather than 4 cycle clearances. These so-called floating bushings worked with a degree of success. Several designs were used in production as better interpretation of engine needs was made (Fig. 28).

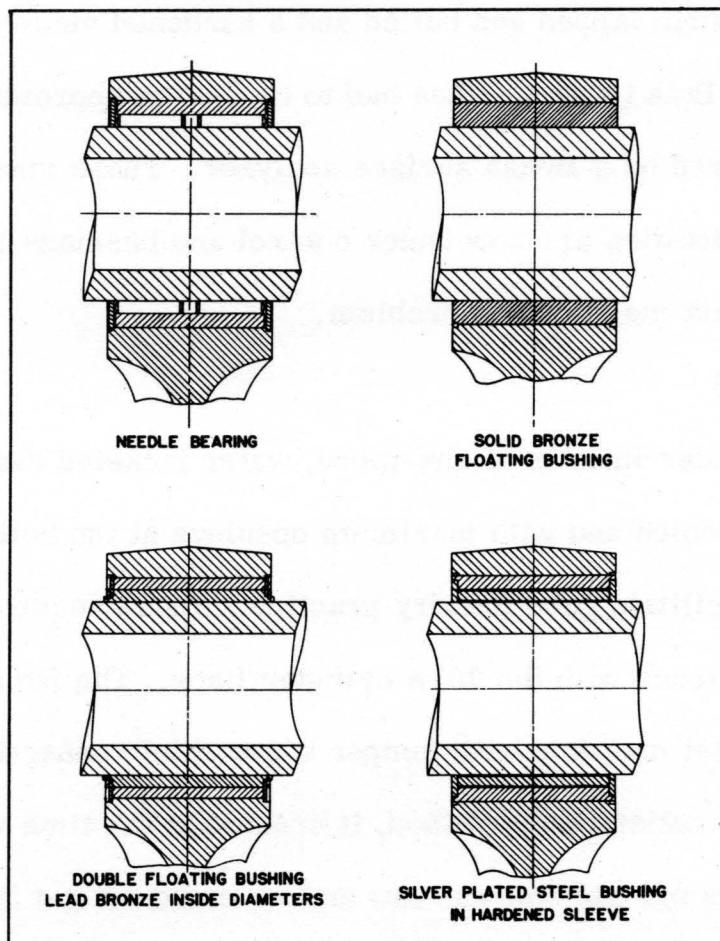

(Fig. 28)

The first was a solid bronze floating bushing with cross grooves, the bushing having approximately one-half inch wall thickness. The second was of two piece construction, the outer piece being steel backed with lead-bronze lining on the inside diameter. The inner piece being of similar construction, the whole assembly was locked into the eye of the rod by means of snap rings. The second design worked quite satisfactorily except for excessive wear on the outside of the soft steel inner bearing and fretting in the eye of the connecting rod.





The final design, which is the current design, is a thin walled, floating bushing of silver plated steel with very close cross grooves. The bushing floats between the hardened pin and a hardened steel sleeve pressed in the connecting rod. This design has proven for the most part quite satisfactory. It is, however, extremely sensitive to finish of the two hardened surfaces and to additive and base stocks of some lubricating oils. It was found the hard way that the piston pin finish had to be ground, lapped and buffed and a hardened sleeve finish had to be ground and honed. Both these finishes had to be held to approximately two micro-inches when measured on a Brush surface analyzer. These manufacturing defects and lubrication difficulties are now under control and bushings in railroad service present no significant maintenance problem.

### CYLINDER LINERS

The cylinder liner is of one-piece, water jacketed cast iron, all inlet ports being water cooled and with maximum openings at the bottom and top of the liner in order to facilitate good foundry practice. These requirements were learned from experience with the 201A cylinder liner. The 201A cylinder liner had an outside water inlet manifold with jumper water inlet connections at the bottom. Whereas this was a satisfactory method, it created at the time very difficult foundry practices as our volume was low and we could not get the foundry interest necessary to correct these difficulties. Since the piston ring life of the 201A was

so low, we felt that coring the cylinder liner open at the bottom and sealing with neoprene seals would be a satisfactory way out because the seals would necessarily be changed every year to year and one-half due to a piston removal for piston rings. With continued piston development the rings lasted much longer than we expected, so even with the one-piece piston we were experiencing water leaks before worn rings or after twelve to fourteen months or 250,000 to 350,000 miles of passenger service.

These seal failures which caused water to go into the lubricating oil were of a very serious nature. A change in the cylinder liner seal groove was made from round to square cross section in order that the seal would not be stressed so high. Continual work was done with the synthetic rubber people to get seals of better characteristics.

2000 HR ENGINE TEST	LAB. TEST AT 250° F. % COMPRESSION SET	APPARENT FIELD SERVICE LIFE MONTHS
 NEOPRENE	85	12-14
 BUNA N EMS 605	50	14-18
 BUNA N AMS 3226B	30	18-24
 SILICONE	8	30-36

(Fig. 29) Cylinder Liner Seal Development

Buna N seals were made and proven to be only slightly better. Further developments in the Buna N compounding were made to eventually get the seal life to approximately twenty-four months or 500,000 miles of passenger service.

With the development of silicone rubber compound, seals were made which look currently to be satisfactory for three years of operation or 750,000 miles of passenger service. This is approximately the life of our current piston rings as well as some of the wrist pin assembly pieces, so that we are fairly well in balance. (See Fig. 29).

Along with the liner seal development, that is, after first reports became available on the Buna N rubber seals, it became apparent that our cylinder liner to head gasket was not satisfactory. The cylinder head gasket was a conventional copper-asbestos type.

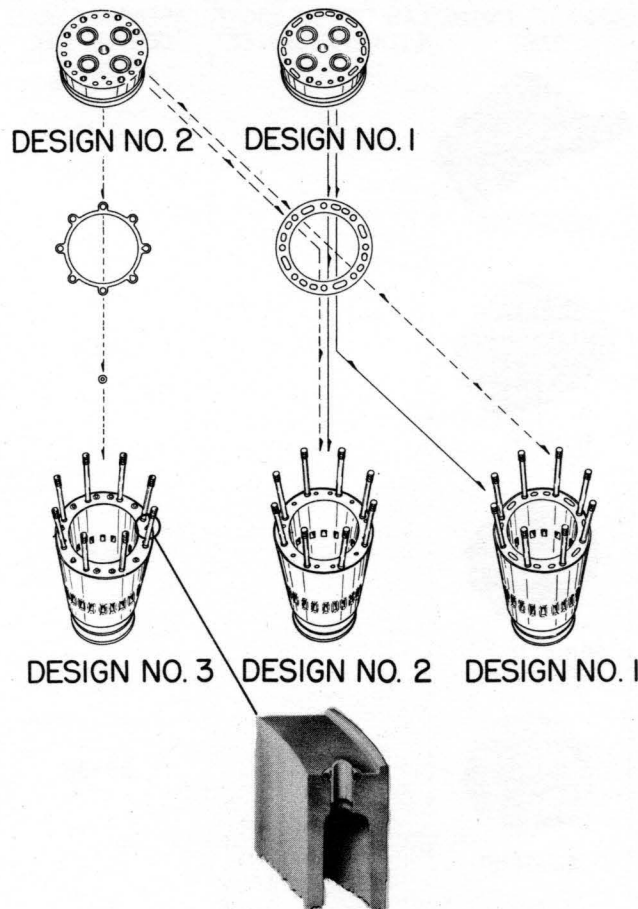

(Fig. 30) Cylinder Head to Liner Seal

Many attempts were made using various types of asbestos, steel instead of copper, etc. to correct the condition. All of these failed. The reason for the failures was that it was necessary to clamp the cylinder head to the cylinder liner with a metal-to-metal connection which did not require continual maintenance or retightening. In 1949 we started into production with such a design which required to some degree non-interchangeability.

As illustrated in Figure 30, it can be seen that the non-interchangeability features did not cause the railroads to scrap any existing material, but rather to supplement the material through the normal wearout of pieces. This design consisted of a ferrule and grommet water connection using silicone rubber grommets. The combustion was sealed by means of a copper shim nominally twelve thousandths thick. This shim surrounded each stud so that a solid metal-to-metal joint could be made between the head and liner with no retightening necessary during normal maintenance.

CYLINDER LINER PORT RELIEF

Cylinder liner scuffing occurred in early 201A engines when straight bore cylinder liners were used.

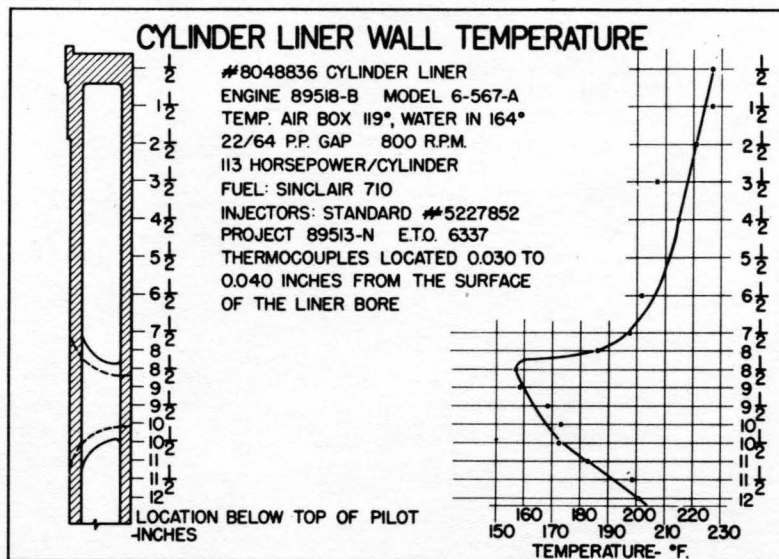

(Fig. 31)

The cooling effect of extremely cold intake air on the liner port struts caused a diametral deviation from the true bore of the liner. Necessity for liner port relief was recognized and was incorporated in the 201A engine early in its history.

Subsequently, tests were run in the 567 engines in the form of cylinder liner wall temperature surveys to confirm the necessity for liner port relief in this design engine. Figure 31 is an illustration of a liner wall temperature survey made in a 567 engine operating at normal rated power. It is apparent that an approximate 40° F. temperature differential exists through the port area which supports the necessity for diametral port relief in the 567 engine to prevent scuffing in this area due to decreased piston to liner clearance.

#### CYLINDER HEAD, VALVE, VALVE GEAR AND CAMSHAFT

Our past experience with the 201A showed us it was necessary to make a compact, rigid, well cooled cylinder head. The 567 head design, therefore, was of the round pot type to give the maximum mechanical stiffness because of its depth diameter ratio.

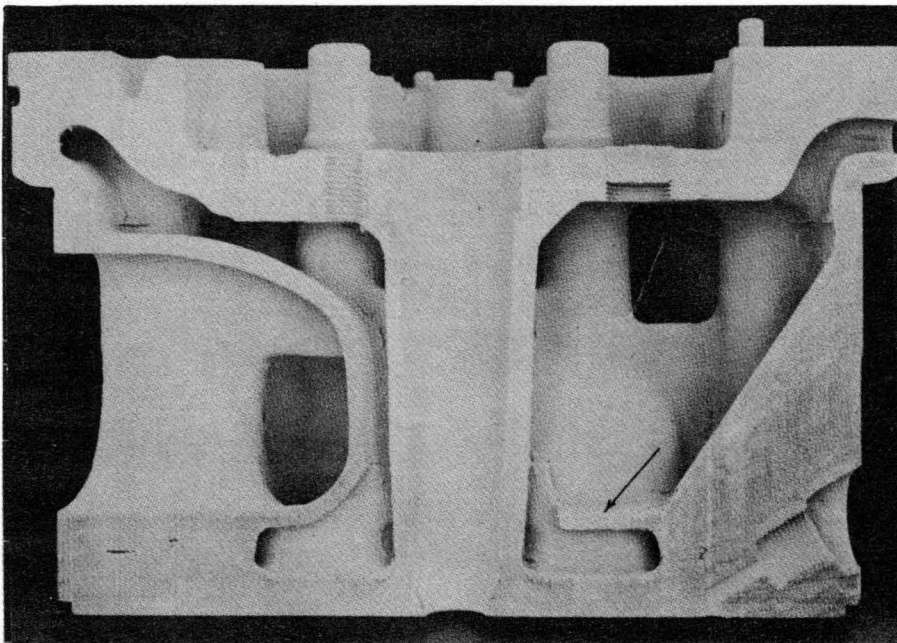

(Fig. 32) Section Present Model 567 Cylinder Head



The better cooling of the head was accomplished by flowing an increased volume of water through the cylinder head and by designing the internal structure of the casting with a so-called false deck. The false deck is a second deck above the bottom face to direct most of the water around the valve seats toward the center and past the injector cavity. Figure 32 illustrates this design.

There are some things in designing an engine which you know for sure which do not turn out to be so. One of these was on the 567 cylinder head. A terrific amount of laboratory work was done to make models for air flow tests in order that we get the maximum efficiency of the exhaust gas flow through the cylinder head. As the gas left the valve seat it passed through a well rounded throat and in through the exhaust passage of the cylinder head. The air flow was measured by models with relation to the actual exhaust valve throat so that the greatest efficiency was obtained. In actual service at a later date we found that carbon deposits built up in this well rounded area, holding the exhaust valve off the seat (Fig. 33).

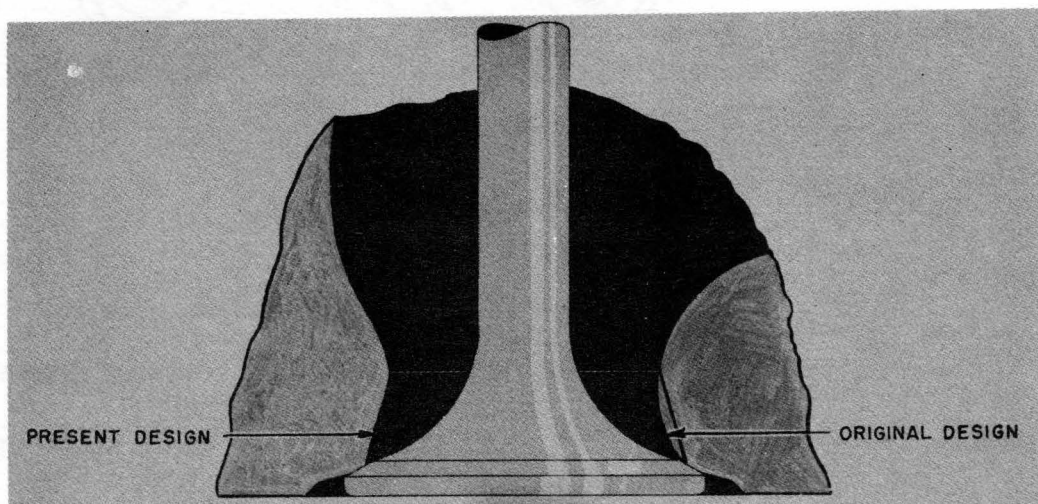

(Fig. 33) Valve Throat Design

To correct this we bored a  $15^{\circ}$  angle hole into the cylinder head directly behind the valve seat and got much better exhaust valve life than we had in the well designed flow tested cylinder head.

The basic structure of the head has remained much the same. Better life has been obtained by the use of higher strength iron, that is from a nominal 35,000 p.s.i. tensile to 50,000 p.s.i. In order to have the maximum accessibility to the valve gear and cylinder head, the direct overhead camshaft with the use of rocker arms was employed, thus eliminating push rods and their frequent troubles. The mechanical type lash adjuster was used on the valve bridge as had been employed on the 201A engine (Fig. 34). The operation of the mechanical lash adjuster was never completely satisfactory as it was contributory to exhaust valve failures.

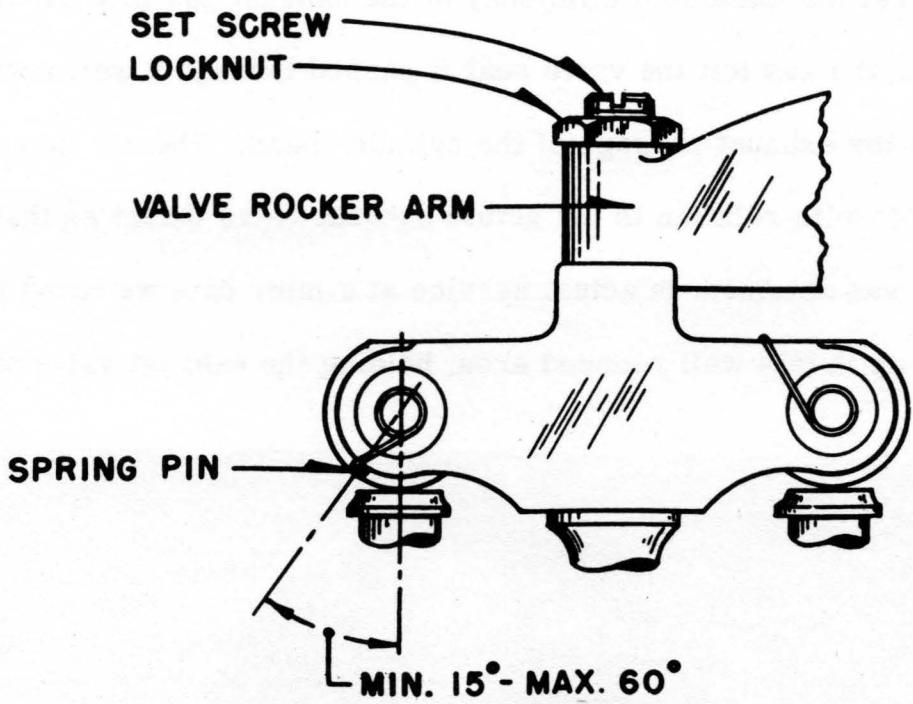

(Fig. 34) Mechanical Valve Lash Adjuster

As you no doubt know, the mechanical cam lash adjuster depends on the friction between the valve stem end or, as in this case, the valve stem cap and the cam itself, the cam being spring loaded in order to maintain zero lash. It was found that the variation in the lubricity or slipperiness of lubricating oils radically changed this frictional characteristic. When the cam of the lash adjuster would rotate due to lack of friction, the exhaust valves would be opened later in the cycle

and closed earlier in the cycle. Inasmuch as the camshaft was designed with a slow opening and slow closing ramp, this malfunctioning of the lash would allow the valve to close at high velocity which induced excessive stresses in the exhaust valve, causing fatigue failure. Since it was rather impractical to design a cam for every frictional characteristic, the valve gear was modified in 1940 to hydraulic lash adjusters of our own design (Fig. 35).

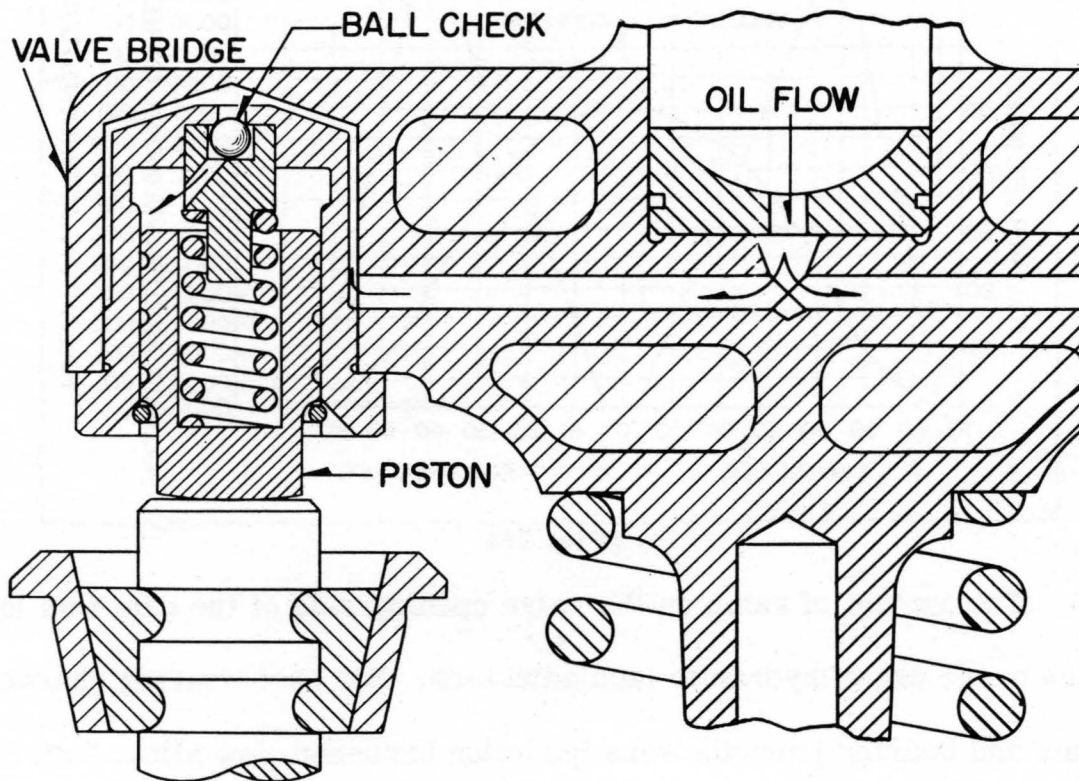

(Fig. 35) Model 567 Hydraulic Valve Lash Adjuster

The camshaft contours for the exhaust valve and injector had been worked out on the General Motors Research 8-1/2x10 single cylinder engine and were copied directly on the first 567 engines. As a result of later tests, the valve timing was slightly changed and a longer dwell added at the maximum valve opening. At this same time the intake port timing was modified. These camshafts were called the 4-4 camshaft, which meant that they opened 4° earlier and closed 4° later. However, they were actually timed in a 6-2 arrangement, that is, opening

6° earlier and closing 2° later. (See Fig. 36). The modification of the intake port timing from 50° before bottom center and 50° after bottom center to 45° before and 45° after, plus the camshaft change, gave us a decrease in specific fuel consumption at rated power of approximately 7%.

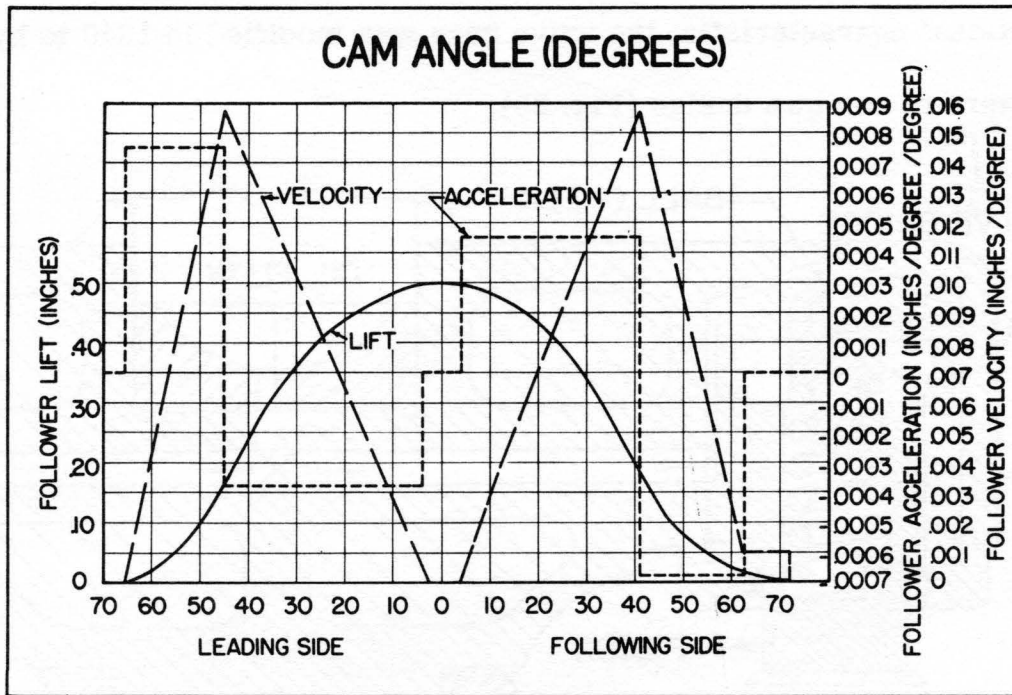

(Fig. 36)

The amount of ramp on the valve opening side of the cam was later reduced due to the use of hydraulic lash adjusters. For best wearing characteristics, both cams and bearing journals were induction hardened, low alloy, high carbon steel. The camshaft assemblies were originally designed with individual segments for each cylinder. Due to experience with replacements on 201A camshafts, the 567 camshaft design proved so adequate on cam and journal life that the segments are now three cylinder lengths for 6s and 12s, and four cylinder lengths for 8s and 16s. This improves manufacturing control of timing and reduces cost.

The exhaust valve was made similar to the 201A valve, but as a result of many tests on the 2 cylinder engine the head diameter was reduced from 3 inches to 2-1/2 inches. This resulted in a much stronger valve and an easier valve

to forge without any loss of efficiency in the exhaust gas flow. It also increased the strength of the cylinder head.

The 567 exhaust valve was first made of 15% chrome, 15% nickel Alloy similar to the 201A valve, but it was thought that a Stellite seat face would give longer life.

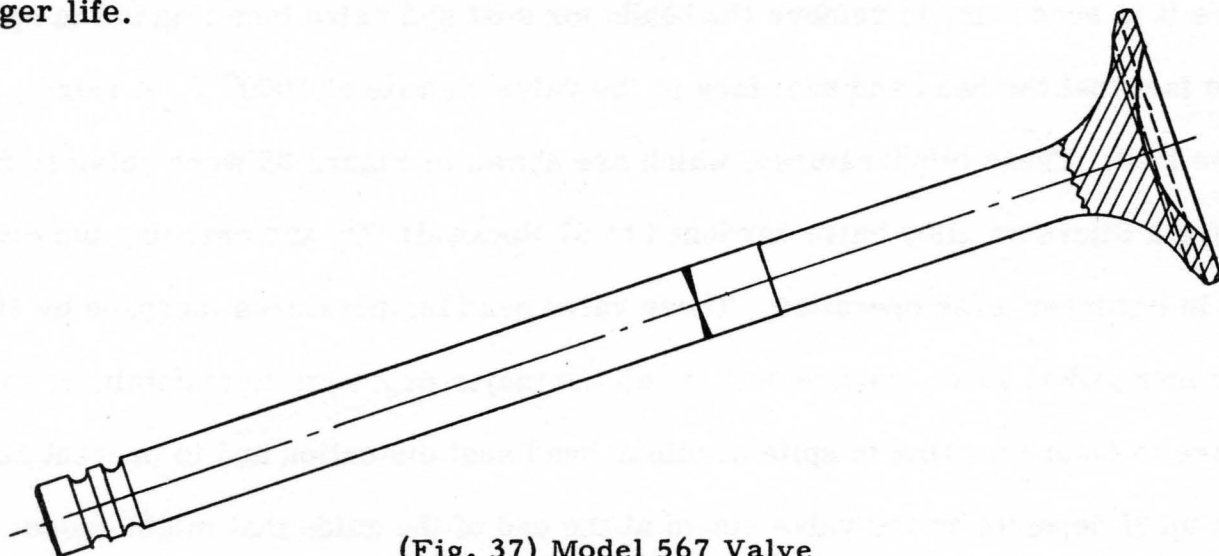

(Fig. 37) Model 567 Valve

The valve head (Fig. 37) was cupped for a more uniform section from the stem out to the face to give some flexibility for seating with minor head seat distortion. The early history of this valve showed more rim failures than we desired. As a result, the hard facing was removed since it was possible that defects at the fusion zone or stresses due to the difference in stiffness of the Stellite and base metal could have contributed to these failures. However, the major reduction in this type failure was effected by the change from mechanical lash adjusters to hydraulic lash adjusters.

In 1942 the valve material was changed to a 21% chrome, 12% nickel for the head and lower stem, with a hardenable alloy steel upper stem to provide better scuff resistance in the stem and to reduce the nickel and chrome use. The 2112 also provided better seat face hardness of 25 Rockwell "C". To prevent wear at the tip of the stem a hard cap was originally used, but in 1946 the tip of the alloy

steel stem was flame hardened and the cap was eliminated. These material and hardness modifications to the original design have resulted in a good service life for the valve.

Normally in freight and passenger service the valve will run two years before it is necessary to remove the heads for seat and valve face regrind in spite of the fact that the head and seat face of the valve operate at 1000° F. at rated engine load. These temperatures, which are shown in Figure 38 were obtained by running a Silchrome alloy valve hardened to 57 Rockwell "C" and checking the draw-back in hardness after operation. These valve head temperatures increase by 100° F. or more when valve leakage occurs, so the major problems in maintaining valve life are to insure seating in spite of minor head seat distortion and to prevent heavy build-up of deposits on the valve stem at the end of the guide that might cause sticking valves. The elimination of valve stem sticking can be adequately accomplished by the use of additives, that is, Heavy Duty lubricating oils.

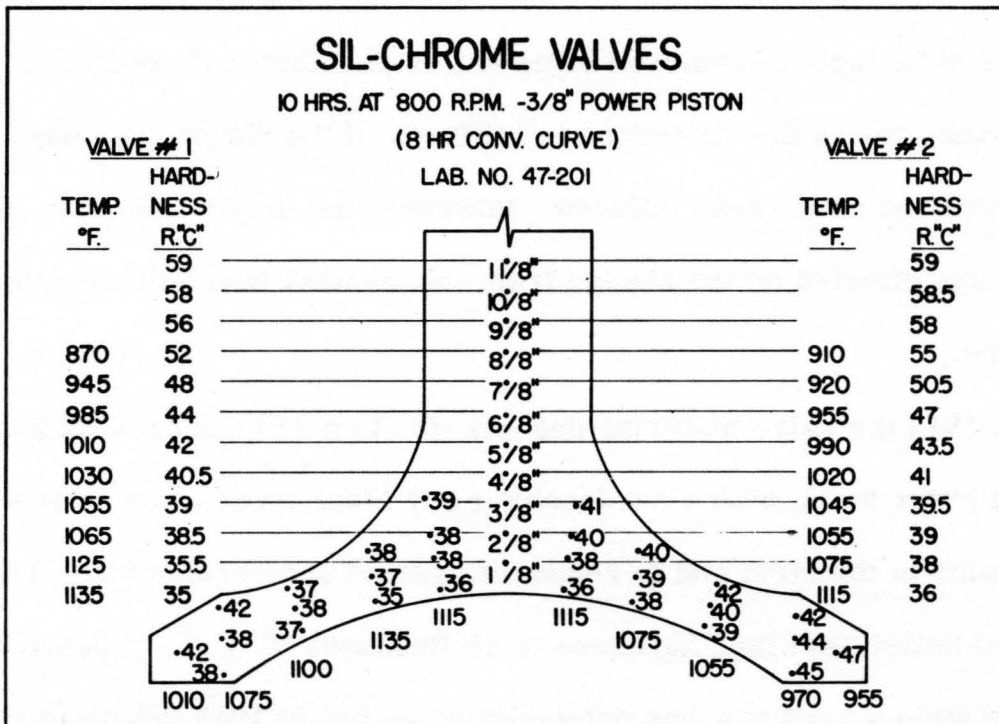

(Fig. 38)

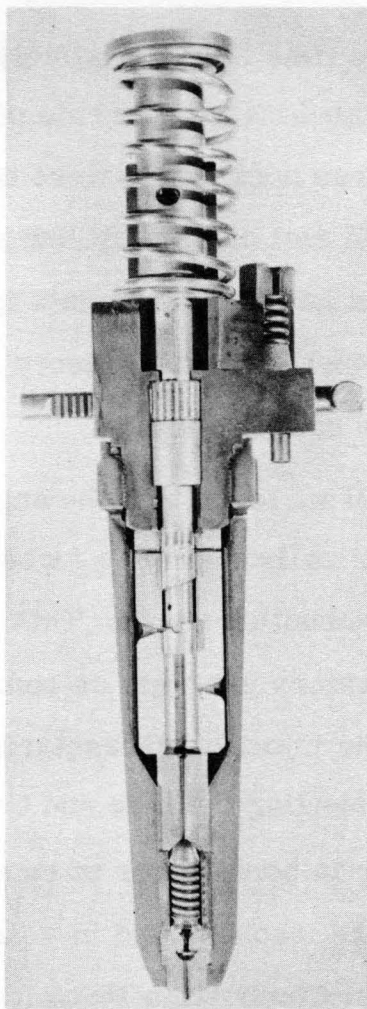

(Fig. 39) Model 567 Injector

## INJECTOR

(Figure 39). A great deal of experience had been gained from the trouble encountered on 201A injectors and injector systems. The 567 engine therefore attempted to correct all of these faults. First of all a through fuel self-bleeding injector and fuel system was designed into the engine. Second, in designing the cylinder head, adequate space was allowed for the injector so that the Injector Design Group would have sufficient space to make large, reliable assemblies. Whereas the outer shape of the injector was changed and simplified with regard to injector timing and output adjustments, as well as fuel fittings, the injector was fundamentally the same with regard to interior work with the exception of injection characteristics.

It was thought at the time that a relatively slow rate of injection was essential in order to reduce knocking or high rate of pressure rise within the cylinder. This at the time was true because we were dealing with a fuel which had very fine characteristics. The fuel had a very low boiling range and extremely high Cetane number. Whereas later developments in recent years with much better instrumentation have proven the original theory somewhat in error, combustion with the high quality fuels was satisfactory.

During World War II we found that the engine would not tolerate the lower ignition quality fuels the railroads were forced to use. The trouble showed up as ring breakage due to combustion shock. This was corrected by a ring design change, but an extensive laboratory program on combustion characteristics was undertaken. We redesigned the injection characteristics to reduce combustion shock and peak pressure by changing the rate and time of injection. This change also resulted in a 2% increase in horsepower at rated load. Details of this particular development program are incorporated in a paper, "A Railroad Diesel Engine Improvement based on Study of Combustion Phenomena and Diesel Fuel Properties" by Barth, Robbins and Lafferty, presented before the Society of Automotive Engineers on September 8, 1948, in Milwaukee, Wisconsin.

### ENGINE BLOWERS

The 201A blower was a Roots type 3 lobe helical blower mounted on the end of the crankcase. The blower was necessarily very large due to its slow speed and as it was mounted on the end of the case, the engine occupied considerable length in the locomotive. In order to shorten the overall engine length the Model 567 engine blowers were mounted on the power take-off end of the engine above the main generator and were made as large as possible commensurate with locomotive installation and ease of maintenance, which requires removal thru the carbody doors for overhaul. The 567 blowers were of the same helical 3 lobe design. One blower was used for all engines through a change of gear ratio and the use of either one or two blowers. This greatly reduced the cost which, of course, is a



direct reflection of savings to the customer. Figure 40 shows the characteristics of the 567 engine blower.

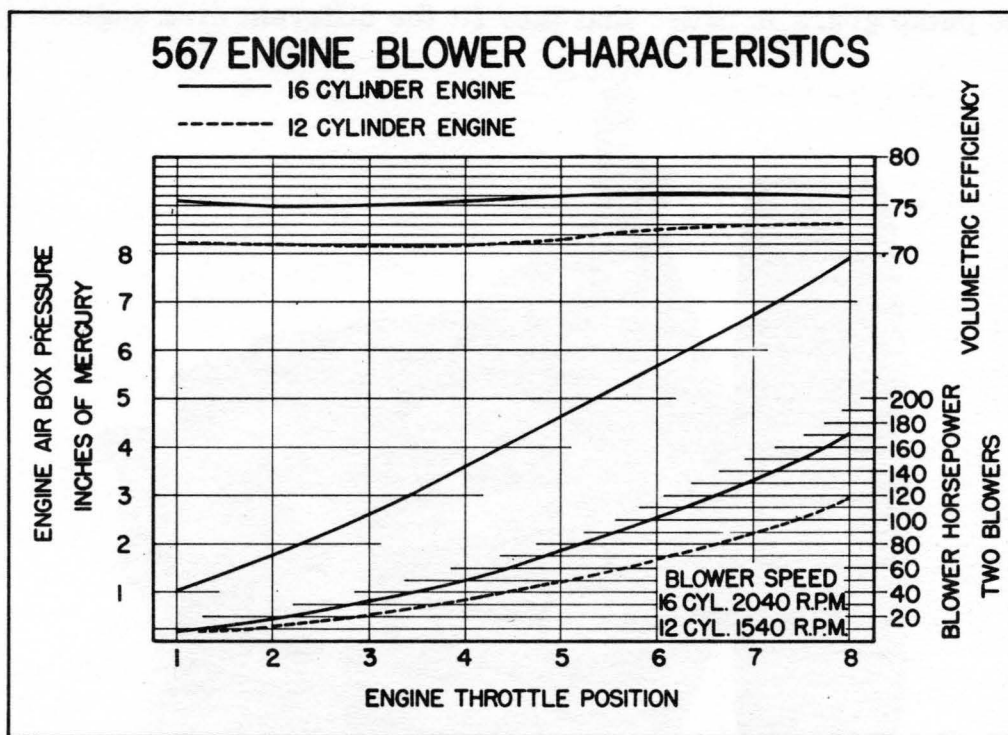

(Fig. 40)

There has been no major change from the original blower design. There have been minor improvements such as improved oil seals as well as a change from high lead babbitt to high tin babbitt in blower bearings. At our current engine ratings the blowers have approximately 27% excess air in the 6 and 12 cylinder engines and 31% excess air in the 8 and 16 cylinder engines. The excess air provides an adequate air supply even at high altitudes to produce clean exhaust.

### LUBRICATING OIL PUMPS

As stated previously, for simplified maintenance it was decided to place the pumps of the engine in an accessible location. All pumps therefore were placed at the forward end of the engine, that is, opposite power take-off end, and are driven through a separate gear train which, as stated previously, was insulated from crankshaft torsional vibration through a flexible drive gear. The lubricating

oil pumps on the complete engine line were made with interchangeable drive gears and the same size pump gears and bores, varying the length of the housings and the length of the pump gears in order that they fit the different size engines (Fig. 41).

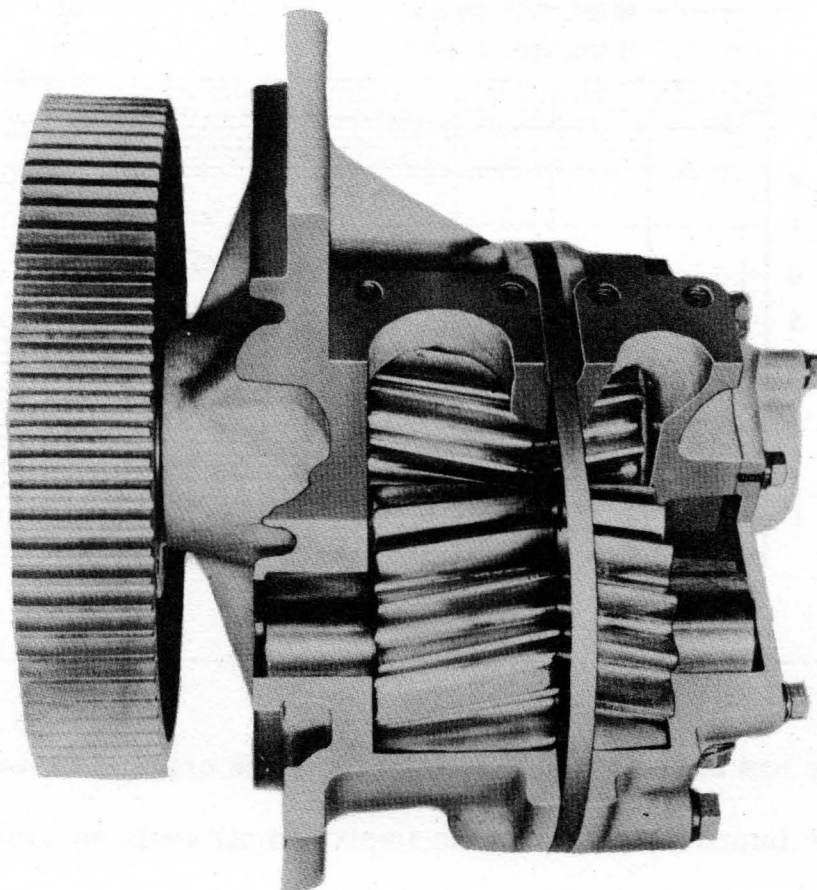

(Fig. 41) Typical Model 567 Oil Pump

The piston cooling system, as explained previously, was kept separate even though retained in the same housing as the pressure pump. Such things as using the piston cooling pump gears of the 16 cylinder engine as the main bearing pump gears on the 8 cylinder engine were employed wherever practical. Therefore a complete line of lubricating oil pumps were developed with the maximum interchangeability of parts.

The pumps are of the helical gear type and are designed to give excess capacity at all times. Figure 42 shows the current capacity of the pumps. In 1946 when the "B" engine was designed which incorporated a direct engine driven

CAPACITIES AND OPERATING PRESSURES OF OIL PUMPS USED ON MODEL 567-B ENGINES			
	PUMP	CAPACITY (ACTUAL) GALLONS / MINUTE	OPERATING PRESSURE LB/IN <sup>2</sup>
6 CYL. ENG.	LUBE OIL	59	60-65
	PISTON COOLING OIL	31	30
	SCAVENGING OIL	117	20
8 CYL. ENG.	LUBE OIL	70	60-65
	PISTON COOLING OIL	31	25
	SCAVENGING OIL	117	20
12 CYL. ENG.	LUBE OIL	86	60-65
	PISTON COOLING OIL	43	26
	SCAVENGING OIL	170	20
16 CYL. ENG.	LUBE OIL	140	60-65
	PISTON COOLING OIL	59	26
	SCAVENGING OIL	248	20

(Fig. 42)

auxiliary generator and main generator blower, the pressure pumps were increased in capacity by 20% as shown on the above chart.

### WATER PUMP

From experience gained on the 201A water pump which was designed and manufactured by an outside source, it was decided to design and manufacture our own water pumps without packing glands but with seals. One of the primary requisites was to design very large capacity water pumps as we had learned from previous experience that the water temperature rise through the cylinder liner and cylinder head should be held to a minimum in order to reduce distortion. It was also necessary to develop a pump which had good hot water pumping characteristics as we felt it essential that the engine jacket temperature be controlled at approximately 180° F. The comparatively high jacket temperatures as a requirement of the engine was essential for two reasons: (1) that it reduced wear and increased engine efficiency; (2) that it reduced the overall weight and cost of the locomotive cooling system.

The first 567 water pumps were designed with friction bearings, pressure lubricated, and radial seals, both of which gave considerable trouble. It was soon found necessary to mount the pump shaft on ball bearings and go to face type carbon seals

The current 567 pump is quite satisfactory from the standpoint of water pumping characteristics as shown in Figure 43, but is still somewhat inadequate in its seal life. Redesigns have been made which show a definite improvement in pump seal life and pump cost.

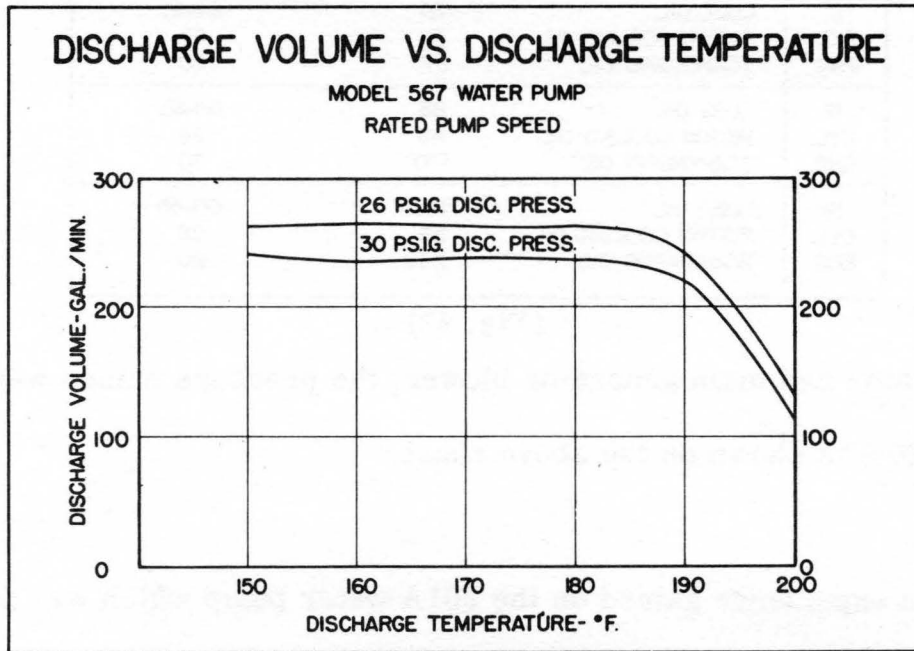

(Fig. 43)

### CAMSHAFT AND BLOWER DRIVE GEAR TRAIN

Due to the complexity of design in the manufacture of the 201A cam drive gear train, it was decided to simplify the design for ease of manufacture. This was a rather serious error in judgment as the original 567 gear trains proved entirely inadequate in road locomotives and much more inadequate in the 16 than on the 12 due to the increased blower horsepower requirements of the 16 cylinder engine. The gear train was originally of helical gear design with pressed-in babbitt lined steel backed bushings. The first design was of 24° helix angle, later was changed to 12° helix angle, and was still later changed to spur gears.

In 1941 a complete redesign of the gear train was made and incorporated in what became known as the 567A engine. A comparison of these two designs can be seen in Figure 44.

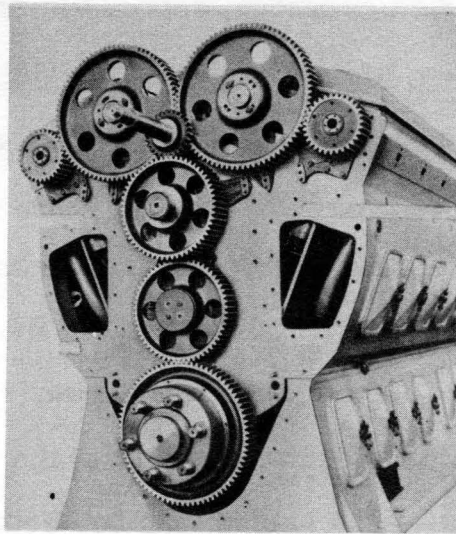

**Current 567 Design**

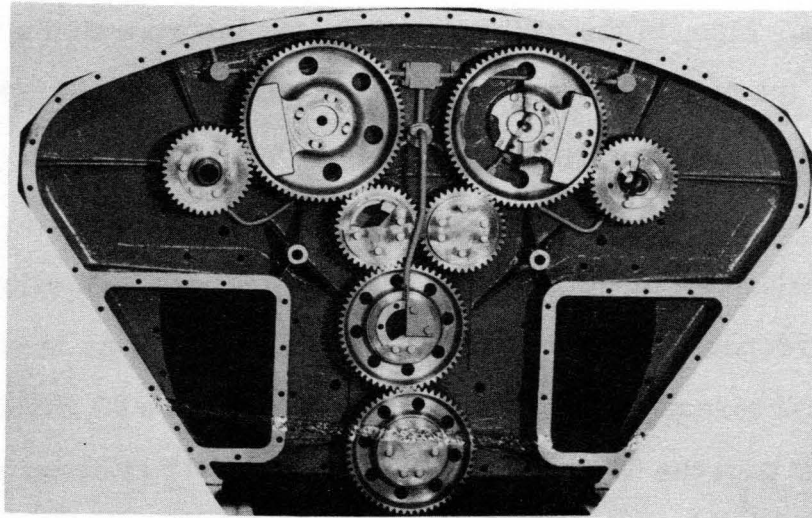

**(Fig. 44) Original 567 Design**

In this redesign the blowers were moved inward, which reduced the maximum width of the engine, the camshaft centers being held the same. The number of idler gears between crankshaft and camshaft was reduced from four to two. The redesign used straight spur gears as were used in the last modification of the first engine design. It incorporated the use of floating bushings rather than pressed-in bushings and, of course, eliminated the thrust problem which was present with the helical gear.

On the basis of our calculations, relative improvement of gear tooth wear for the new gear train vs. the old gear train was 2.8 to 1. This is based on Buckingham's wear factor formula. In actual service the new design has shown about a 4 to 1 improvement, that is, 8 years vs. 2 years on the 16 cylinder engine. This 4 to 1 improvement is no doubt due to the increased area as well as better lubrication of the gear bushings which, in the case of the first design, caused premature gear tooth wear due to loss of center distance.

The 567B gear train is identical to that of the "A" excepting that the stub shaft for the two idlers is one-piece rather than two separate stub shafts, the oil being fed to the gears through cored passages rather than through externally mounted oil lines. This was done because some trouble was encountered with breakage of the "A" gear train oil lines due to extremely high frequency, low amplitude vibrations. Also, in the "B" gear train was incorporated a wider upper idler in order to drive the auxiliary generator drive gear, - thus the upper idler drives both a camshaft gear and an auxiliary generator drive gear.

#### CRANKSHAFT AND MAIN BEARING

The crankshaft of the 567 engine is drop forged, low alloy carbon steel with induction hardened main and crankpin journals. Stiffness is obtained by the increase of journal size over the 201A crankshaft. Figure 45 illustrates this comparison of the 567 with the Model 201A. The 6, 8, and 12 cylinder crankshafts are single drop forgings whereas the 16 cylinder is made up of two sections, flanged and taper dowel bolted together between the two center main bearings. All crankshafts are made by the conventional drop forged and twisted method. Dynamic balancing was added in 1942, the balance being obtained to plus/minus 1 inch-pound. The only design change in the crankshaft since the original design was a reduction of hardness in journals from a nominal 58 Rockwell "C" to 43-50 Rockwell "C". No additional shaft wear has been experienced since this change was made in 1942. The change was made for manufacturing reasons so as to avoid grinding cracks plus the additional insurance against severe cracking in the event of loss of

lubrication oil in service. All crankshafts are drilled with pressure lubrication of main and rod bearings.

COMPARISON OF UNIT BEARING PRESSURES		
ENGINE	567 12 CYL.	201-A 12 CYL.
PISTON AREA	56.7 SQ. IN.	50.1 SQ. IN.
<b>MAIN BEARING</b>		
DIAMETER	7 1/2"	6 3/4"
LENGTH	4 1/4"	4 1/8"
PROJECTED BEARING AREA	31.9 SQ. IN.	27.8 SQ. IN.
MAX. LOAD 1200 P.S.I. FIRING PRESS.	40,000#	65,550#
MAX. UNIT BEARING PRESSURE	1252 P.S.I.	2350 P.S.I.
<b>FORK ROD BEARING</b>		
DIAMETER	6.5	6.0
LENGTH	5.958	2.847
PROJECTED AREA	33.53	17.1
MAX. LOAD	60,500#	60,000#
MAX. UNIT BEARING PRESSURE	1810 P.S.I.	2850 P.S.I.
<b>BLADE ROD BEARING</b>		
DIAMETER	7.69	
LENGTH	3	
PROJECTED AREA	23.1	
MAX. LOAD	64,500#	
MAX. UNIT BEARING PRESSURE	* 2790 P.S.I.	
* BEARING MATERIAL 10% TIN 15% LEAD 75% COPPER BLADE ROD SURFACE 60 ROCKWELL "C"		

(Fig. 45)

Main bearing lubrication in the 567 engine is from the top through the unloaded upper bearings instead of through the lower main bearings as in the case of the 201A. This meant that a solid lower main bearing could be used free of grooves. We felt it essential from experience not to groove the loaded half of the main bearing as this doubles the actual bearing load. See Figure 46 for lubricating oil system.

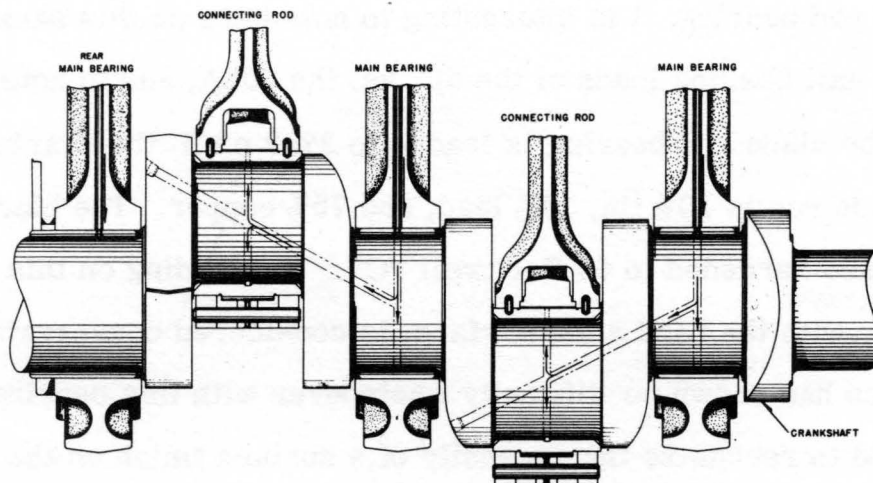

(Fig. 46) Crankshaft Bearing Lubrication

The main bearing design has remained the same through the past fourteen years except that the bearing metal has been improved. The original design was a steel back high lead babbitt which was later changed on 16 cylinder engines in 1940 to steel back lead bronze. After approximately 150 engines, all production was changed to steel back lead bronze with a flash lead tin coating to provide better break-in qualities, especially when applied on used crankshafts.

During World War II it was necessary that we change all main bearings to solid lead bronze with lead tin coating because of material shortages on steel tubing. During the war, methods were developed to make the lead bronze bearings by casting on rolled steel strips butt welded, the split line then cut through the weld. The steel back lead bronze bearing then supplanted the solid bronze bearing which was subject to fatigue failure.

Again looking at Figure 45, it can be noted that the 567 main bearing unit pressure is extremely low. Subsequent field experience has shown us a minimum of main bearing troubles. An extremely high percentage of all main bearing and crankshaft troubles, perhaps 95% or more, can be blamed on the lack of lubrication caused by foreign material or dirt, water or fuel in the lubricating oil system. This is particularly true since going back to the steel backed lead bronze lined bearing.

Whereas we have already given a complete description and history of the connecting rod bearing, it is interesting to note here on this same chart the comparison of unit bearing loads of the 567 vs. the 201A, and to note especially that whereas the blade rod bearing is loaded to 2790 p.s.i. the bearing material supporting the blade rod is 10% tin, 15% lead, and 75% copper. The blade rod surface is carburized and hardened to 60 Rockwell "C". The loading on this bearing material, together with the hard steel surface, is considered conservative. Actual field experience has shown no difficulty whatsoever with this bearing excepting where we failed to recognize the necessity of a surface finish on the slipper rod end of less than 3 micro inches.



## CRANKCASE

The crankcase of the 567 engine was developed to overcome the basic weaknesses of the 201A (Fig. 47).

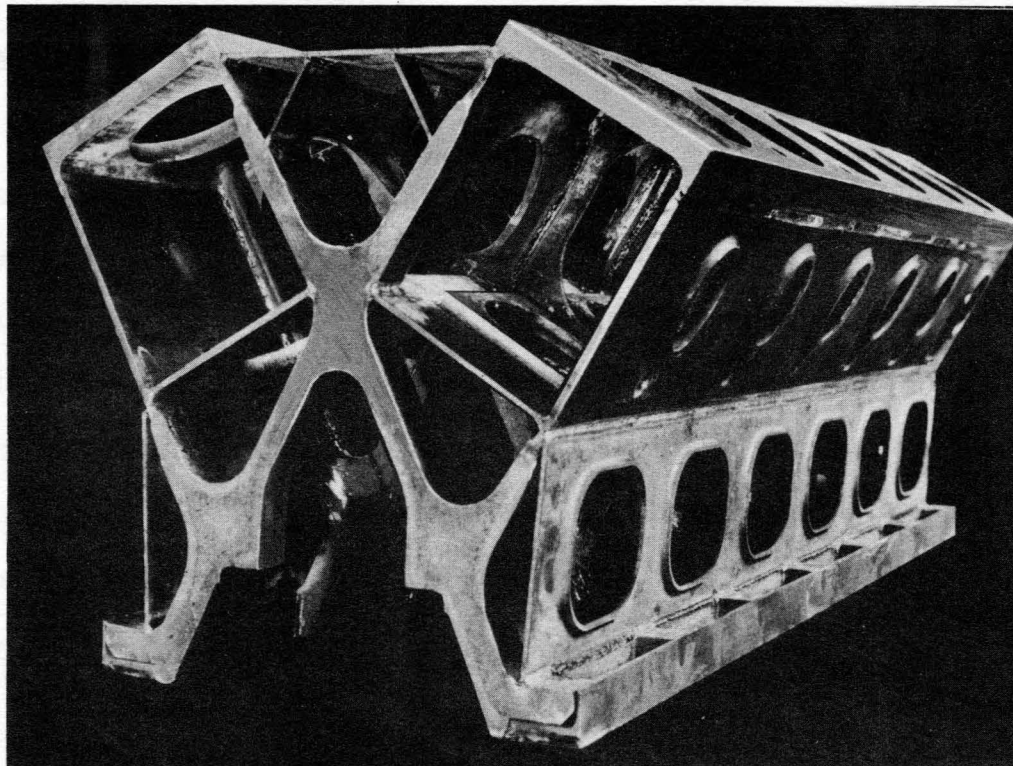

(Fig. 47) 12-201A Fabricated Crankcase

First, it is necessary to understand that the 201A engine was basically weak in the crankshaft and main bearing support, and in developing the new 567 crankcase these weaknesses had to be overcome. The 201A crankcase had been designed around 900 pounds per square inch maximum firing pressure. Early tests run with an indicator showed 860 pounds per square inch. However, much later when better indicators were available it was found that with average railroad fuels maximum firing pressure was in the range of 1100 pounds per square inch. This fact, plus the rather flexible foundation which was necessarily true in locomotive mounting, increased stresses sufficient to produce fatigue cracks in the main bearing support. The main bearing studs were inadequate and even though made from the highest strength materials possible, still were very sensitive to failures. The

stud failures were probably due to the inability of the dowels to satisfactorily hold the main bearing caps from horizontal movement. The 60 degree "V" of the 201A probably increased this tendency. There were other objections to the 201A crankcase, such as very poor visibility of pistons and rings for inspection purposes, inadequate tie plates between the two banks of the "V" as well as very expensive and almost impossible fabrication problems.

The 567 crankcase was designed for increased diameter and length of main journals and shorter pins due to the use of fork and blade connecting rod design. Because the engine was designed for locomotive installation, it was decided that the movement, i.e. twisting of the engine which necessarily occurs in locomotive installation, could not be permitted to cause crankshaft misalignment. This fact precluded then standard engine design practices of installation of the shaft in the engine base. Since the shaft could not be allowed to deflect under load in the vertical plane, the basic crankcase was devised to support the crankshaft at the bottom of the "V" structure which carried the firing loads directly from the cylinder head down through the fabrication in a system which can best be described as being similar to a pair of slings corresponding to the sides of each "V". The crankcase structure was mounted on a flexible oil pan which in turn mounts to the carbody floor, the mounting to the carbody floor being at four points and not the customary chocking as is generally used in marine practice. Thus, movement of the mounting points does not result in bearing misalignment, but does result in a twisting of the oil pan about the crankshaft center line. In order that the main bearing caps have zero horizontal movement, they were serrated full length parallel to the crankshaft. Subsequent tests and field results have shown that by the use of serrations as well as adequate studding, all fretting between the cap and crankcase has been eliminated.

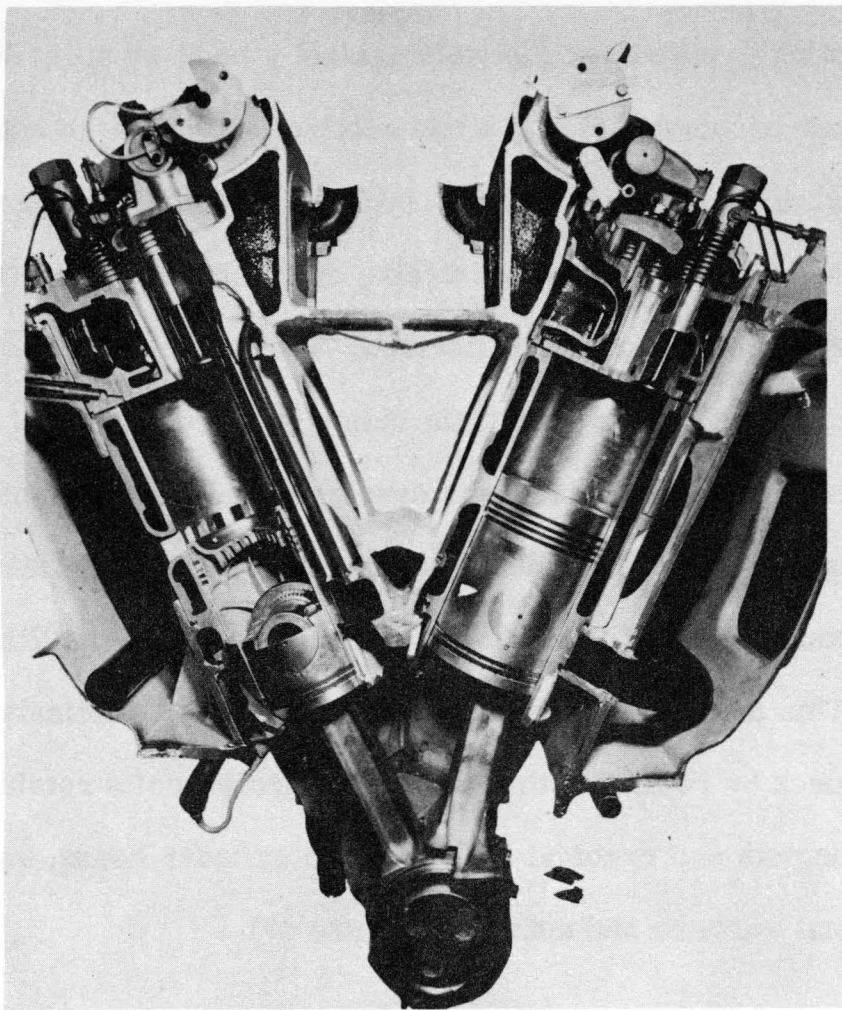

**(Fig. 48) Section-Original 567 Design**

**(Fig. 48).** The original crankcase was calculated at 1200 pounds per square inch firing load. Extremely heavy, low carbon steel main bearing forgings were used welded to low alloy, high tensile strength stress plates, which in turn were welded to a cast steel top deck. The cylinder heads were clamped in the cast steel top deck by means of studs and crabs. The cylinder liner in turn was bolted to the cylinder head and was piloted in the crankcase. This same basic design was used in the whole series of 567, 567A, 567B and 567C engines.

Much field difficulty was experienced, particularly in the weld of the stress plate to the cast steel top deck. This difficulty can be blamed on two things. First, we were attempting to weld to cast steel which in some cases contained burned-in sand. This made welding inadequate due to slag inclusions, etc. Second,

we were attempting to automatically weld against a back-up strip which in some cases did not fuse properly, leaving a bad notch effect which, of course, increased stress beyond working limits and fatigue failures resulted. There were approximately 600 of these crankcases made, twelve of which were 16s. Only four of these twelve were placed in railroad service. They were retired after about three years of service. A retirement program is now in effect for all of these cast top deck crankcases. A new crankcase was developed and went into production in early 1940 using a fabricated top deck, and can be most readily identified by a change in the exhaust well of the engine, which lies between the V's from a U shape to a V shape. This design simplified top deck machining, eliminated the studding of the cast top deck by replacing the studs with through bolts retained by crabs at the bottom of the pots and crabs at the top of the cylinder heads, using self-aligning spherical washers and nuts (See Figure 49).

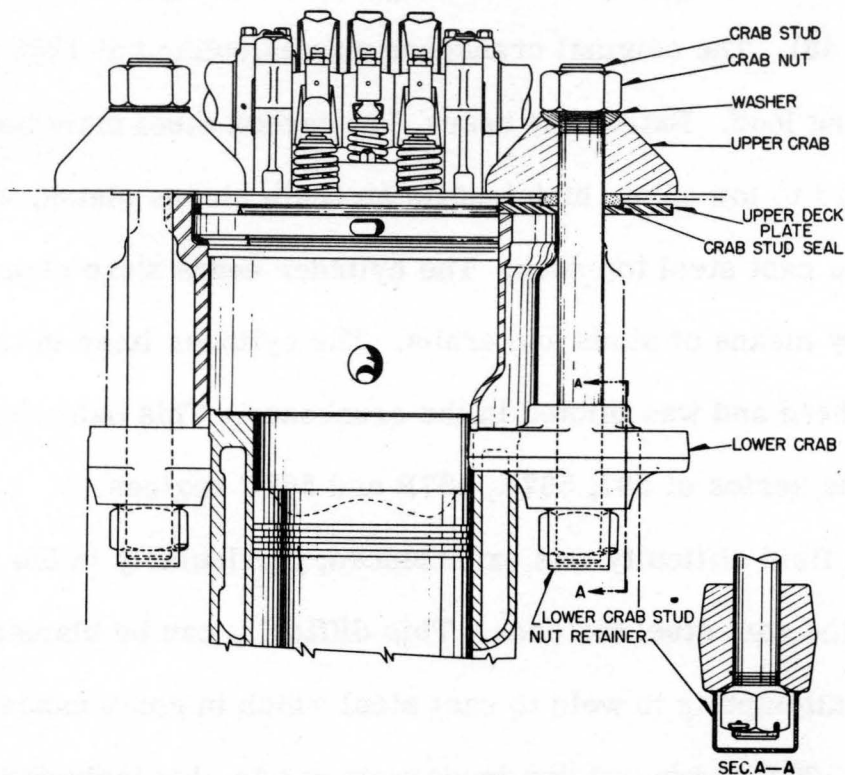

(Fig. 49) Cylinder Head Retention

By 1941 it was desirable to further simplify the crankcase, and the flat top deck Model 567A crankcase was developed. This crankcase was first used on the 12 cylinder LST engines which started in production early in 1942. The crankcase incorporated a flat tie plate the full length of the engine which provided a flat surface for mounting exhaust manifolds and lift hooks (See Figure 50).

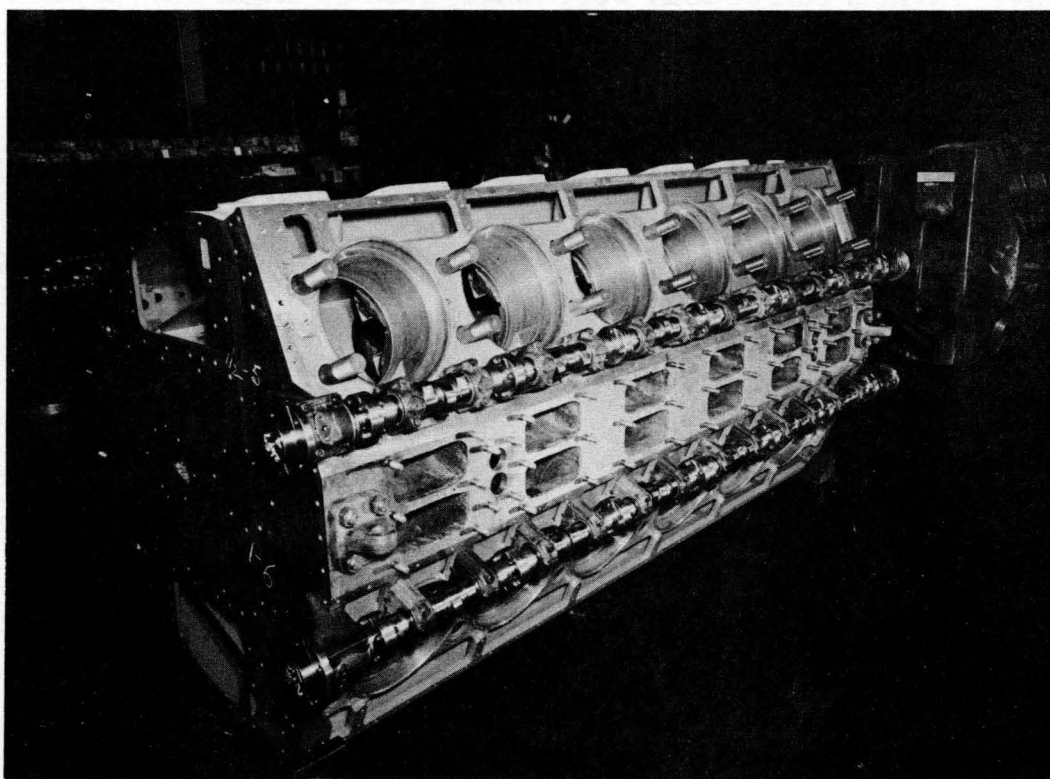

(Fig. 50) Model 567-A Crankcase

It was at this time that the gear train was simplified from four to two idler gears as explained previously. The cast steel cylinder head retainers were simplified over the second 567 design.

In 1946 a new line of crankcases, designated as the 567B, were introduced which were basically the same as the 567A except for a change to permit the mounting of the auxiliary generator drive gear. About three or four months after the introduction of the "B" engine the cylinder head retainer castings, which had been a continuous source of production problems, were replaced with steel

forgings. Whereas both the "A" and "B" crankcase calculated to be of very low stress value in their main structures, minor fatigue cracks have appeared in field service. The complexity of a structure of this type is such that it cannot be fully calculated, so that in 1947 and 1948 after development of the SR-4 stress gauges had taken place, the crankcase structures were stress analyzed both statically and dynamically. Various corrections were made, such as slight alterations of gussets, etc. (Fig. 51) to reduce stress where fatigue cracks occurred.

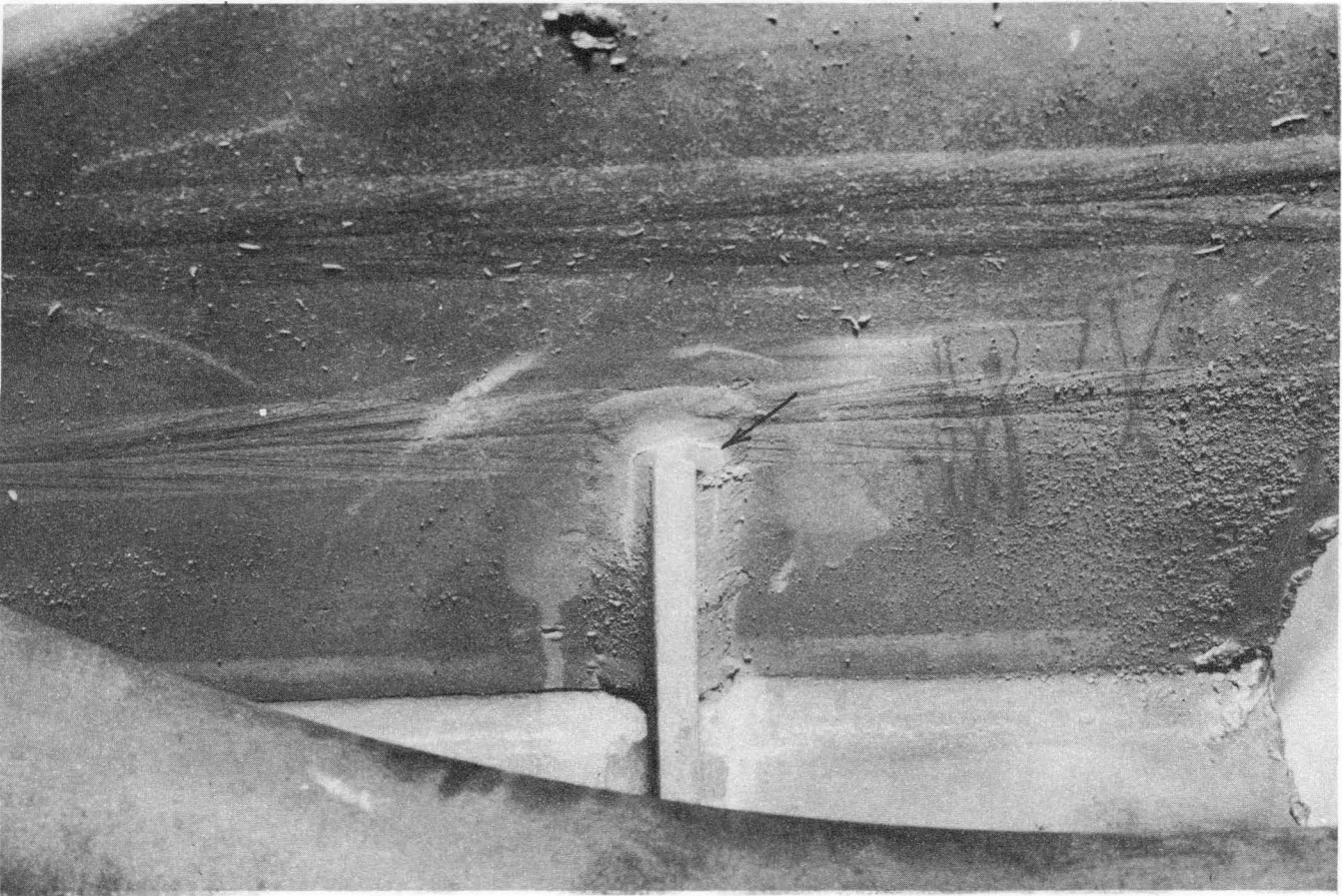

(Fig. 51) Ill. Central R.R. Crankcase 1495 Gusset Weld Failure

Similar stress analyses and corrections were made to oil pans. A considerable amount of work has been done along these lines so that at the present time in the current "B" engines it has been impossible to find any stresses in parent metal above 5000 p.s.i. It also has been impossible to find any stresses in welds, where notch effects may act as stress raisers, above 2500 p.s.i.

## FUTURE DEVELOPMENTS

We are in the final stages of developing a new crankcase to be known as the Model 567C which will further improve our product. One premise of this design has been to eliminate water on any stressed member of the crankcase because of corrosion difficulties. In the earlier crankcases just described, cracks have occurred in the area of the cooling water which were caused by corrosion fatigue (See Fig. 52).

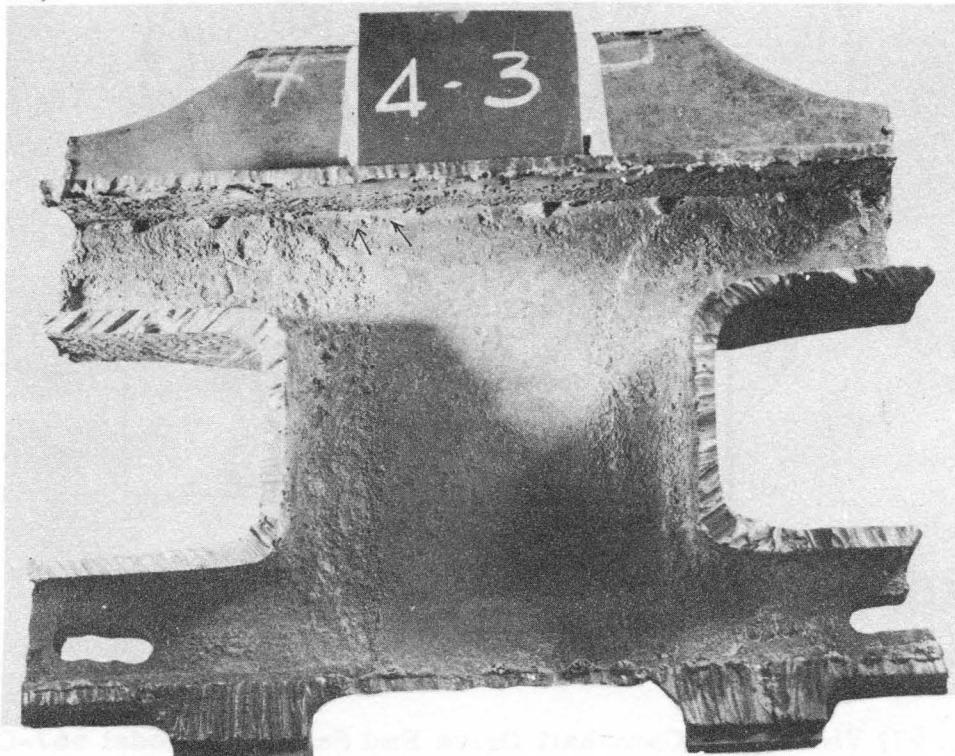

(Fig. 52) Stress Plate Cracks in Engine No. 1835, Santa Fe R.R.

The elimination of water on the stress members is accomplished by furnishing cooling water to the cylinder liners through a bolted-on manifold and stopping the stress level at the heavy top deck so as to eliminate any stress around the water cooled exhaust passage (Fig. 53). Stress has been further reduced in the basic load carrying members by increasing weld area and increasing the size of the load carrying members. The same basic principle of structure is carried out in the "C" design as in the earlier designs.

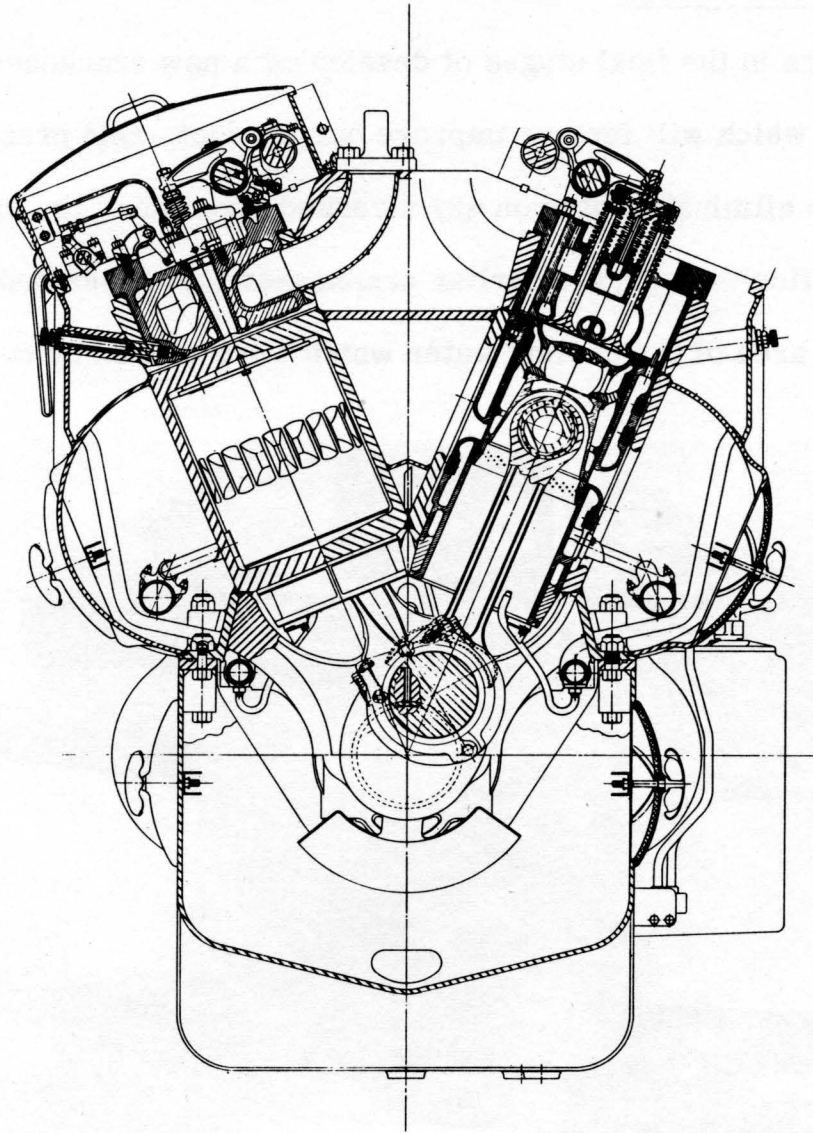

**(Fig. 53) View from Camshaft Drive End Section - Model 567-C**

The entire fabrication has been simplified through the use of heavy rolled sections to make up the main stress members. Complex forgings are used in the top deck in place of the many steel stampings, thereby reducing a tremendous amount of fitting and manual welding. These two items together will not only reduce the amount of manual welding but will permit more accessible manual welding. As this design lends itself very well to automatic welding, much manual welding will be eliminated and the product should result in a much lower production cost as well as a much lower maintenance cost.



A maximum amount of interchangeability has been obtained in the "C" engine as the engine actually only requires new cylinder liners and cylinder heads. Since liners and heads are expendable items it is not considered that this will affect interchangeability to any degree. Several other new things have been added to the "C" engine such as a reduction of gasketed joints and therefore a reduction of oil leaks on the generator end of the engine, as well as a changed cylinder head frame and cover and fuel transfer lines. These items, however, are applicable to "B" engines and therefore can be used for improvements on existing "B" engines. The engine also has a changed oil pan to crankcase joint which uses the metal to metal principle of bolting crankcase and oil pan together and sealing by use of a Silicone round seal in a square groove. This type of construction is also applicable to "A" and "B" engines and is currently being released for the "B" engine.

Whereas one of the primary reasons for the "C" crankcase was to eliminate water on stressed members, as explained above it was also of first importance that we eliminate the necessity of removing cylinder liners for water leaking into the lubricating oil. As previously explained, the Silicone liner seals have proven quite satisfactory for three years, which is the approximate life of piston rings. Current developments on pistons and rings, as well as on wrist pin and connecting rod designs, point to a much longer life for these parts, so we feel it essential, having developed casting methods for cylinder liners and heads to permit the use of jumpers for inlet and outlet water connections, that we make this forward step (Fig. 54).

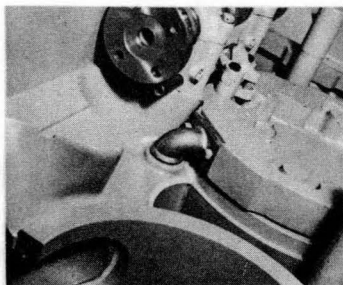

**Upper Water Jumper from Cylinder Head**

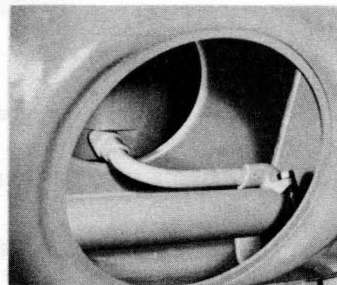

**Lower Water Jumper to Cylinder Liner**

**(Fig. 54)**

It can be noted that both the inlet and outlet jumpers can be changed without the removal of any major parts in a very short time, and that only one gasket or sealed joint exists between the water system and oil system, namely the water out jumper. This can be visually inspected and changed in a few moments time.

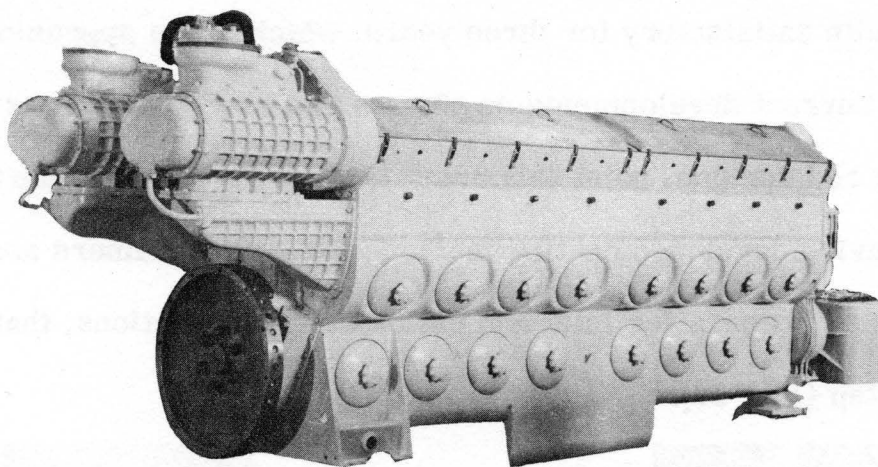
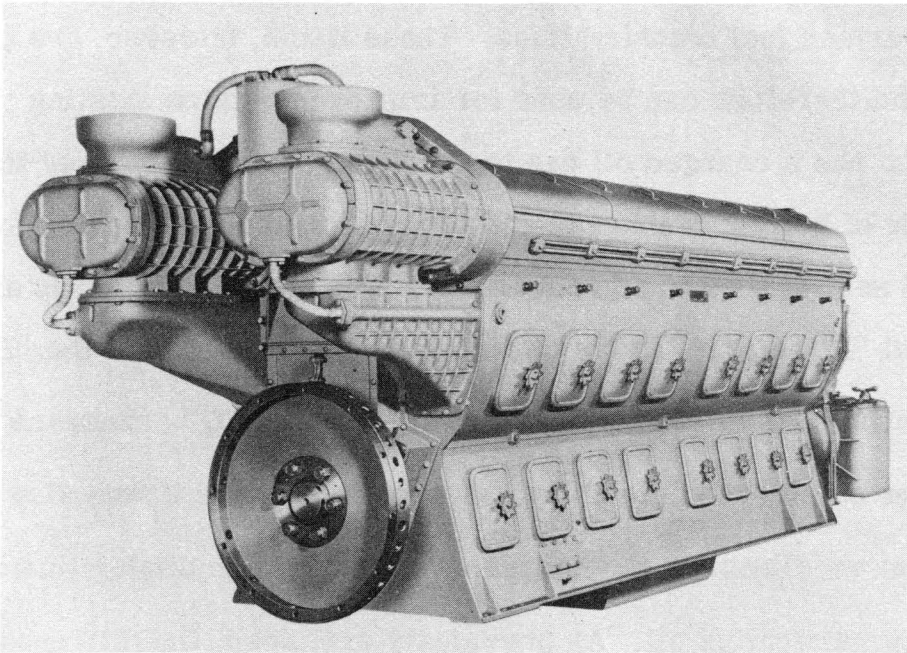

(Fig. 55) Comparison 16-567B and 16-567C Engines

Figure 55 shows the outside appearances of a 16-567B and a 16-567C engine. We have four engines built and two are undergoing test at LaGrange. The results of these tests will dictate our future policy.

One of the developments, as mentioned in a previous paragraph (Fig. 56) is a new design piston pin carrier and wrist pin, which we choose to call the trunnion carrier and piston.

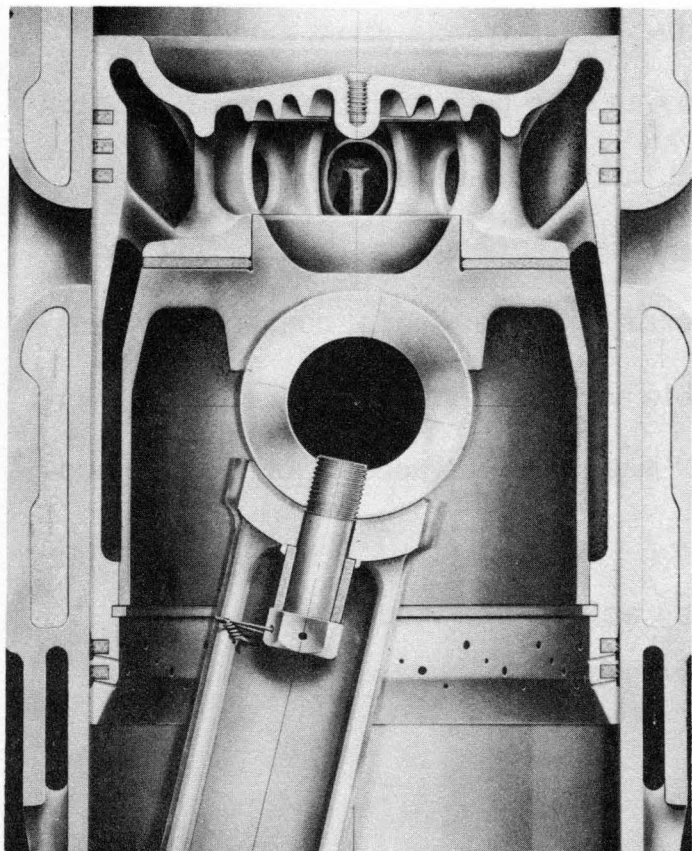

(Fig. 56)

Trunnion Type Piston Pin and Carrier

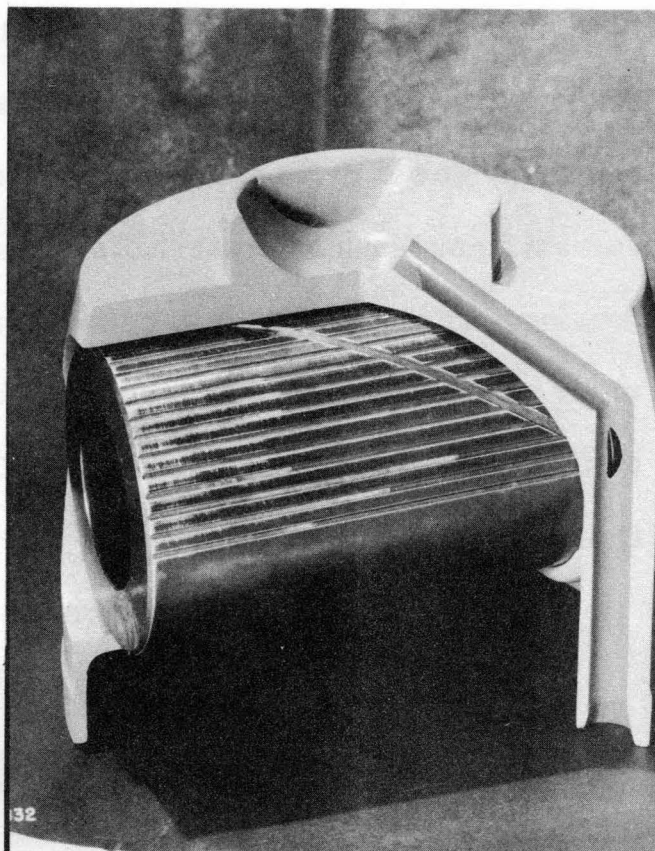

(Fig. 57)

Lubrication of Trunnion Type Piston Ring

The design involves a forged steel carrier, oil hardened, in which floats a silver plated piston pin, the bearing material being on the piston pin. The piston pin is lubricated by means of grooves as shown in Figure 57. The connecting rod is bolted to the pin and the whole carrier is retained in the piston by means of a snap ring. This design has undergone laboratory test and is now undergoing field test. The area of the wrist pin bearing is increased from 10 square inches to 22 square inches, which should greatly extend the life of this assembly. The entire assembly, that is, piston, piston pin, carrier and connecting rod is interchangeable in any 567 engine ever built.

## SUMMARY

In summarizing, it might be well to remind you that from the first 567 engine in 1938 through the current Model 567B engine in 1951, we have not only increased durability and reliability, as described in detail, but to a great degree have maintained interchangeability. All the pieces from a given model of 567B design can be used in any 567 engine that was ever built with the exception of the camshaft-blower drive gear change which was made in 1941. This means that current items such as crankshafts, camshafts, main bearings, connecting rod bearings, wrist pins, pistons, cylinder heads, cylinder liners, connecting rods, water pumps, oil pumps etc. can be used in any model crankcase. Further than this, any current engine including the "C" engine can be used in any 567 locomotive model that was ever built.

Because of increased volume as well as interchangeability, it has

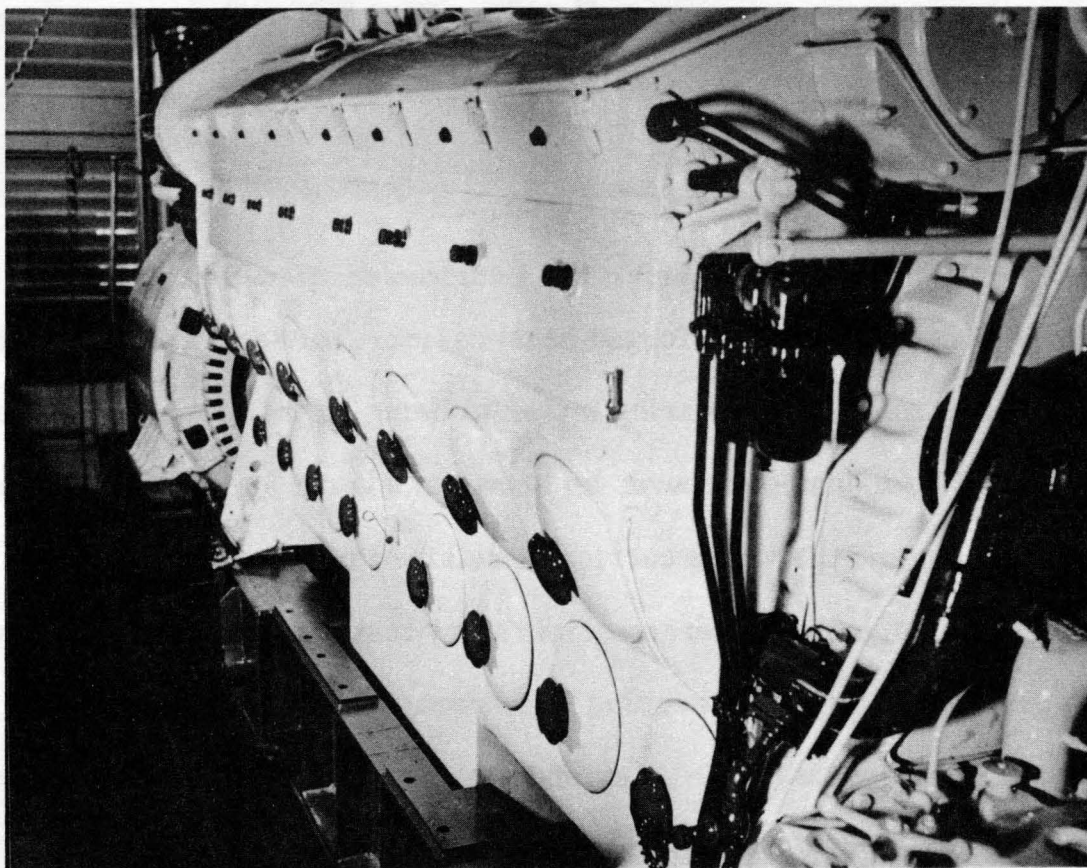

(Fig. 58) 16-567C Engine on Test

been possible to maintain a low sale price of the engine in spite of rising costs. In 1941 a 16-567 engine sold for \$24,000. Since that time materials have increased on an average of 64%. Labor has increased an average of 106%. On this basis the same engine would sell today for \$43,560 or an increase of 82%. However, today our 16-567B engine sells for \$32,905 or an increase of 32% over 1941. In other words, improvements in design and manufacturing of this engine have reduced the cost approximately 25%.

In addition to the future developments which have been mentioned throughout this paper, we are well equipped for and are going ahead with many other engine developments too numerous to list here. It might be well to show you a few pictures (Fig. 58 and 59) of one of our engine test cells and add that there are six such test cells for full scale experimental testing at Electro-Motive Division.

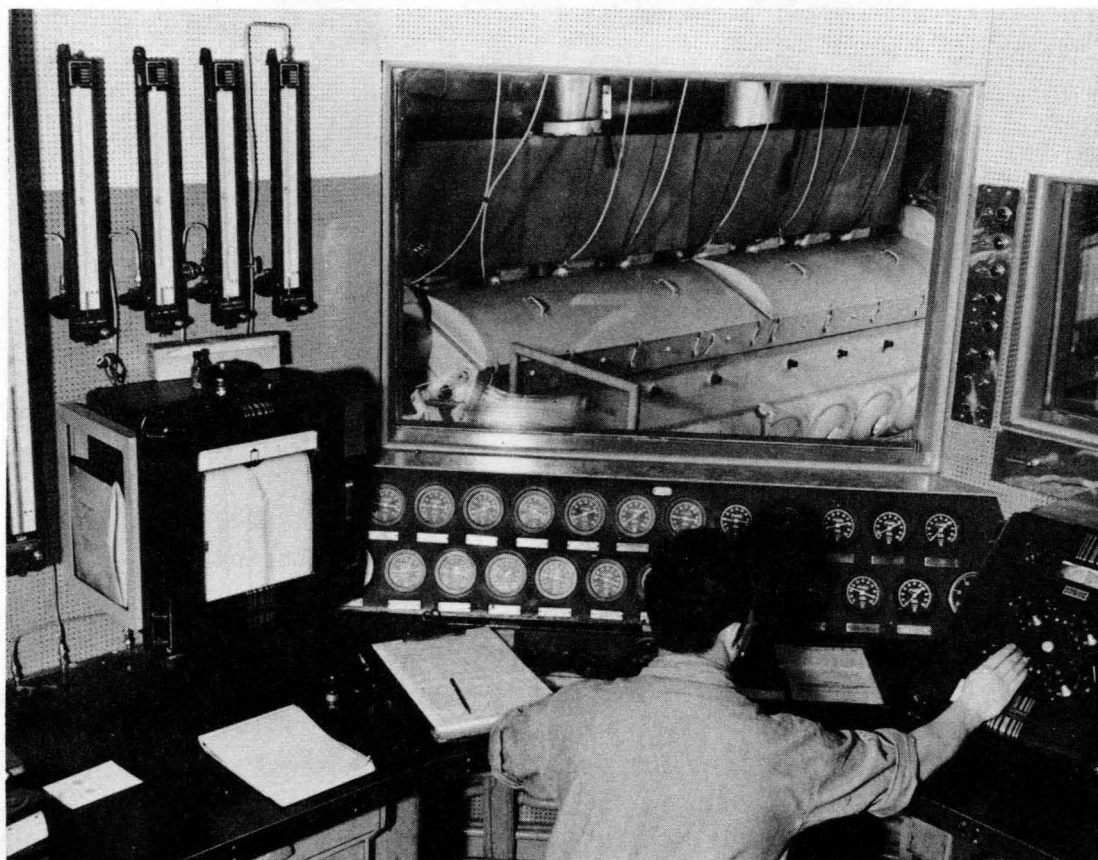

(Fig. 59) Experimental Test Cell Control Room

We currently have two 2-cylinder 567B engines on which we are further investigating combustion as well as five multi-cylinder engines on which we are durability testing many new designs (Fig. 60). Currently we have a total of 228 active experimental projects, 188 of which are being carried out in the Experimental Department at LaGrange and 40 of which are being carried out in the field on twenty-one different railroads. Durability testing of engines is currently running about 400 hours per engine per month on four of our six engines.

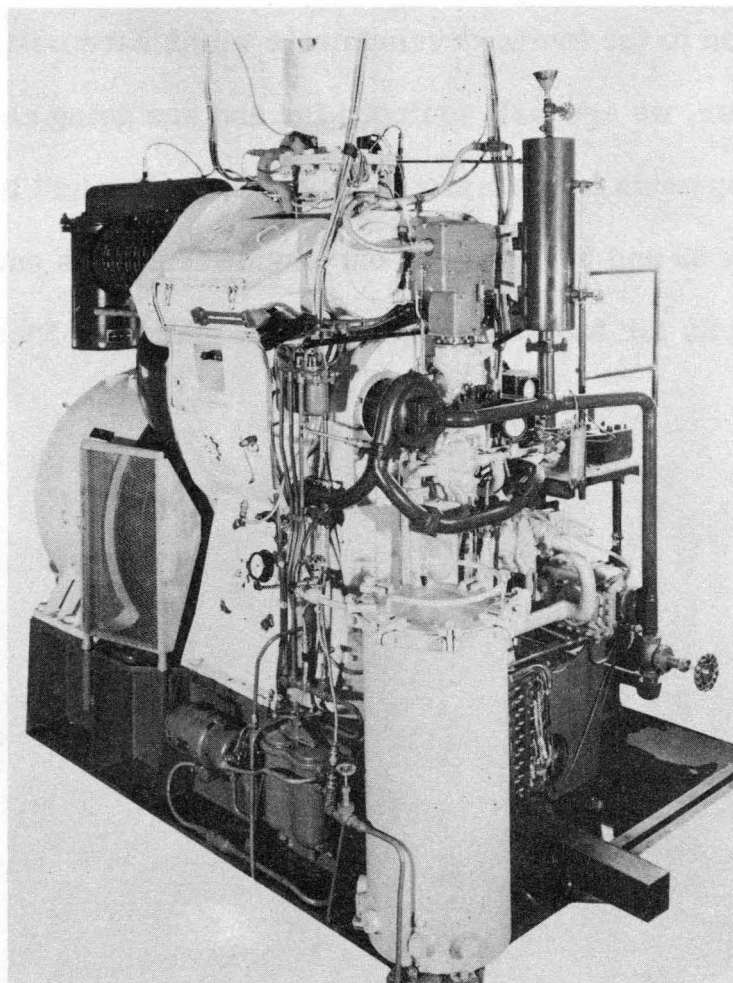

(Fig. 60) Two Cylinder 567B Test Engine

You have noted, no doubt, throughout the paper many references to field results and field testing. We have found that even with the engine testing laboratory at LaGrange it is necessary for us to field test a great many things prior to production. The railroads have been extremely cooperative in accepting experi-

mental material for field tests, or accepting new locomotives which contain experimental material for testing. Without this cooperative effort of the railroads it would have been impossible for us to advance our product to its present state of reliability. In the future we will have many new things which will require field testing with two definite objectives in mind, - one, that of increasing durability and reliability of the product and, two, reducing the cost of the product so that the value to the customer will be increased.

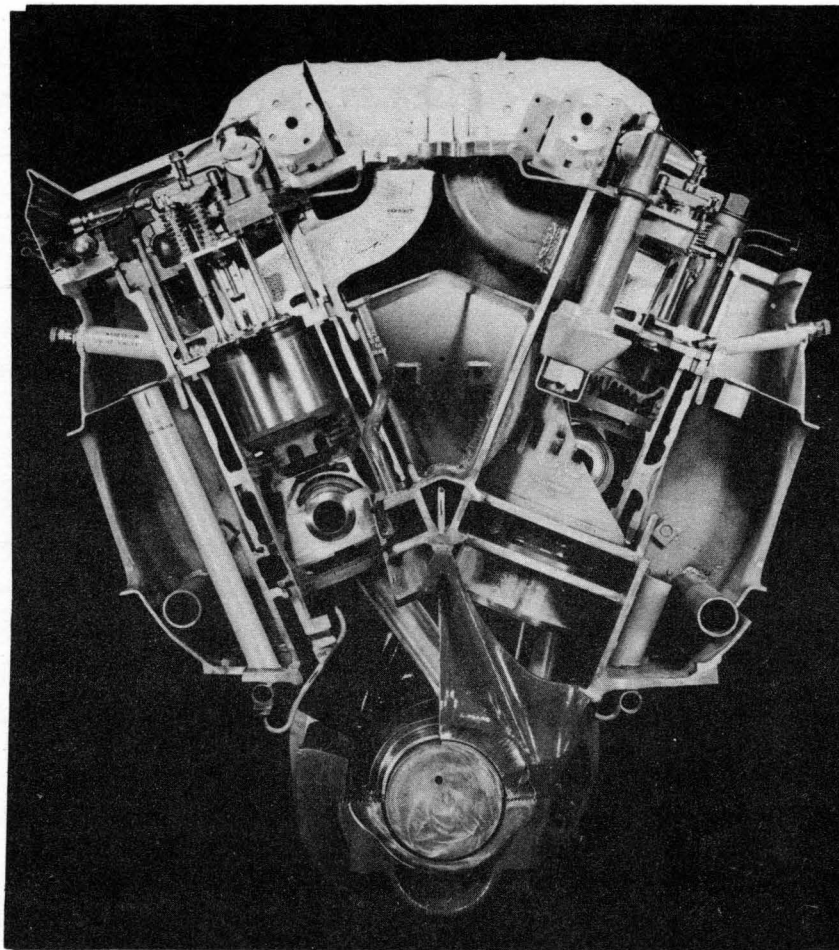

**(Fig. 61) Model 567-B Engine Cross Section**

Figure 61 shows a typical cross-section of the current 567B series of engines. A careful study will show the connecting rod and piston construction, the entire crankcase structure, and the ease of assembly and disassembly of the engines.

In closing it must always be kept in mind that the 567 engine was neither designed or developed by any super intelligent or analytical mind. The engine has dictated every improvement that has been made. We, at Electro-Motive, have only done our best to interpret what the engine was trying to tell us.

I want to thank Wade Barth, Chief of our Power Plant Section, and his staff for technical help, and Jack Norris for help in doordinating the material which went into this paper.

<b>EVOLUTION OF THE GM SERIES 567 DIESEL ENGINE</b>									
MODEL	MFR.	FUEL	CYLINDERS	BORE	STROKE	RPM	HP-NOM.	WT-LB.	LB-HP.
106	WINTON	GASOLINE	6	7	8	1050	175	4270	24.4
106A	"	"	6	7 $\frac{1}{4}$	8	1050	220	4270	19.4
120	"	"	6	7 $\frac{1}{2}$	8 $\frac{1}{2}$	1050	275	4520	16.4
6-146	"	"	6	8	10	900	300	7814	26.1
8-148	"	"	8	8	10	900	400	9995	24.9
12-194	"	DISTILLATE	12	9	12	900	900	18,000	20.0
12-201	"	FUEL OIL	12	8	10	750	900	13,200	14.7
12-201A	"	"	12	8	10	750	900	18,500	20.5
12-567	EMD	"	12	8 $\frac{1}{2}$	10	800	1000	24,000	24.0
12-567A	"	"	12	8 $\frac{1}{2}$	10	800	1000	24,000	24.0
12-567B	"	"	12	8 $\frac{1}{2}$	10	800	1200	24,000	20.0
12-567C	"	"	12	8 $\frac{1}{2}$	10	800	1200	25,000	20.8

(Fig. 62)



**GENERAL SPECIFICATIONS**  
**567 ENGINES**

---

**I. GENERAL INFORMATION**

Manufactured by: <b>ELECTRO-MOTIVE DIVISION, GENERAL MOTORS CORPORATION</b>	
	La Grange, Illinois
Type . . . . .	45 <sup>0</sup> "V" Uniflow
Service. . . . .	Locomotive Power Plant
Drive . . . . .	Direct Connected to Generator through Flexible Coupling
Starting System . . . . .	Special Series Winding on Main Generator Energized by 64 Volt Battery
Starting Speed . . . . .	75-100 R.P.M.
Idling Speed. . . . .	275 R.P.M.
Rated Speed. . . . .	800 R.P.M.
Maximum Speed (Overspeed Trip Setting) . . . . .	910 R.P.M.
Rated Output at 60 <sup>0</sup> F to 1000 Ft. Altitude (11/32 Power Piston) . . . . .	106 HP/Cyl.
Friction Horsepower at Rated Speed (Approx.). . . . .	28 HP/Cyl.
Mechanical Efficiency . . . . .	79%
Compression Pressure at Idle . . . . .	475 p.s.i.
Compression Pressure at Rated Speed . . . . .	600 p.s.i.
Combustion Pressure at 106 B.H.P./cyl. . . . .	1095 p.s.i.
B.M.E.P. at 106 B.H.P./cyl. . . . .	92 p.s.i.
Cylinder Type . . . . .	Single Acting
Cycle . . . . .	Two
Cylinder Scavenging . . . . .	Roots Type Blower
Piston Type . . . . .	Full Floating Trunk
Piston Cooling . . . . .	Individual Nozzles Direct Pressure Stream of Lube Oil into Piston Cooling Chamber
Injection System . . . . .	Unit Injectors
Fuel Oil:	
Specific Consumption at Rated Speed & Load	.390 lbs./bhp-hr. <u>Max.</u>

**I. GENERAL INFORMATION (Continued)**

Fuel Oil Used . . . . .	See Specifications
Lubricating Oil:	
Specific Consumption at Rated Speed & Load	.0027 lbs./bhp-hr. Max.
Lubricating Oil Used . . . . .	SAE-40 See Specifications
Engine Weight per Horsepower (actual) . . . . .	17.9 lbs./H.P.

**II. PISTON AND CONNECTING ROD**

Piston Type . . . . .	Full Floating Trunk
Piston Diameter . . . . .	8-1/2 in.
Piston Stroke . . . . .	10 in.
Piston Length . . . . .	12 in.
Piston Head Area . . . . .	56.75 sq.in.
Piston Displacement per Cylinder . . . . .	567.5 cu.in.
Compression Ratio (Nominal) . . . . .	16:1
Compression Rings . . . . .	Three (3) Filled Cast Iron
Oil Control Rings . . . . .	Two (2) Double Hook Cast Iron
Piston Pin Type . . . . .	Full Floating
Connecting Rod Type . . . . .	Fork and Blade
Left Bank . . . . .	Fork
Right Bank . . . . .	Blade
Connecting Rod Length . . . . .	22 in.
Ratio of Connecting Rod Length to Piston Stroke	2.2:1
Blade Rod Slipper:	
Angle of Contact . . . . .	138°
Projected Area . . . . .	22 sq.in.
Average Piston Speed at Rated Speed . . . . .	1333 F.P.M.

## II. PISTON AND CONNECTING ROD (Continued)

Maximum Piston Speed . . . . .	2100 F.P.M.
Total Reciprocating Weight per Cylinder . . . . .	85.4 lbs.
Maximum Force Due to Combustion Pressure at 106 BHP/Cyl.	59,500 lbs.

## III. CYLINDER LINER

Type . . . . .	Removable Cast Iron - Integral Water Jacket
Bore Diameter . . . . .	8-1/2 in.
Length . . . . .	21-15/16 in.
Number of Ports . . . . .	20
Port Height . . . . .	1-5/16 in.
Port Width . . . . .	11/16 in.
Port Angle . . . . .	10°
Total Port Area . . . . .	18.02 sq.in.
Ports Open . . . . .	45° BBDC
Ports Closed . . . . .	45° ABDC
Duration of Opening . . . . .	90°

## IV. CAMSHAFT, VALVE GEAR AND INJECTOR

### Camshaft:

Type . . . . .	Built-up Assembly of Segments, 1 per 4 Cylinders
Number of bearings . . . . .	Two per Cylinder
Bearing Size . . . . .	2-1/2 in. dia. x 2-3/8 in. long

#### IV. CAMSHAFT, VALVE GEAR AND INJECTOR (Continued)

##### Maximum Cam Lift:

Exhaust Cam . . . . .	.500 in.
Injector Cam . . . . .	.5474 in.
Rocker Arm Ratio . . . . .	1.371:1
Camshaft Counterweight Timing . . . . .	Both Rear End Weights at Lowest Position when #1 Piston 105° A.T.D.C. Front End Weights at Uppermost Position at this setting.

##### Exhaust Valve:

Number per Cylinder . . . . .	4
Diameter of Head . . . . .	2-1/2"
Diameter of Stem . . . . .	.622-.6225 in.
Valve Seat Angle . . . . .	30°
Lift (Zero Lash) . . . . .	.686 in.
Valves Open . . . . .	78° B.B.C.
Valves Closed . . . . .	60° A.B.C.
Duration of Opening . . . . .	138°
Exhaust Port Area Per Valve . . . . .	2.46 sq.in.

##### Valve Spring:

Free Length . . . . .	4-1/8 in.
Length - Valve Closed . . . . .	3-3/8 in.
Load - Valve Closed . . . . .	117 lbs.
Length - Valve Open . . . . .	2-11/16 in.
Load - Valve Open . . . . .	225 lbs.

##### Injector:

Stroke . . . . .	.750 in.
------------------	----------

##### Maximum Output of Injector

Timing . . . . .	Injector begins 20° B.T.C. Injection ends 0° B.T.C.
------------------	--

IV. CAMSHAFT, VALVE GEAR AND INJECTOR (Continued)

Output per Stroke . . . . .	600 mm.
Rated Engine Output: 106 BHP/cyl.	
Timing . . . . .	Injection begins 16° B.T.C. Injection ends 1° B.T.C.
Output per Stroke . . . . .	475 mm <sup>3</sup>
Zero Load:	
Timing . . . . .	Injection begins & ends 4° B.T.C.
Ratio Injector Rack Travel to Governor Power Piston Travel . . . . .	1.335:1.000
Tip:	
Number of Holes . . . . .	6
Diameter of Holes . . . . .	.0116 in.
Spray Cone - Included Angle . . . . .	150 °
Average Tip Velocity . . . . .	1245 ft./sec.
Injector Fuel Supply Pressure - As Installed in locomotive	35 p.s.i.

V. CRANKSHAFT AND MAIN BEARINGS

Crankshaft:

Type . . . . . Drop Forged Induction Hardened Journals

Main Journals:

Diameter . . . . . 7-1/2 in.

Main Bearings:

Length:

Intermediate . . . . . 4-1/4 in.

16 Cyl. Center . . . . . 3-1/2 in.

V. CRANKSHAFT AND MAIN BEARINGS (Continued)

12 Cyl. Center . . . . .	5-1/2 in.
Generator End . . . . .	6 in.
Connecting Rod Bearing (Crankpin Side):	
Length (Upper) . . . . .	5.958 in.
Length (Lower) . . . . .	5.968 in.
Crankpin Diameter . . . . .	6.5

VI. CAMSHAFT AND BLOWER DRIVE GEAR TRAIN

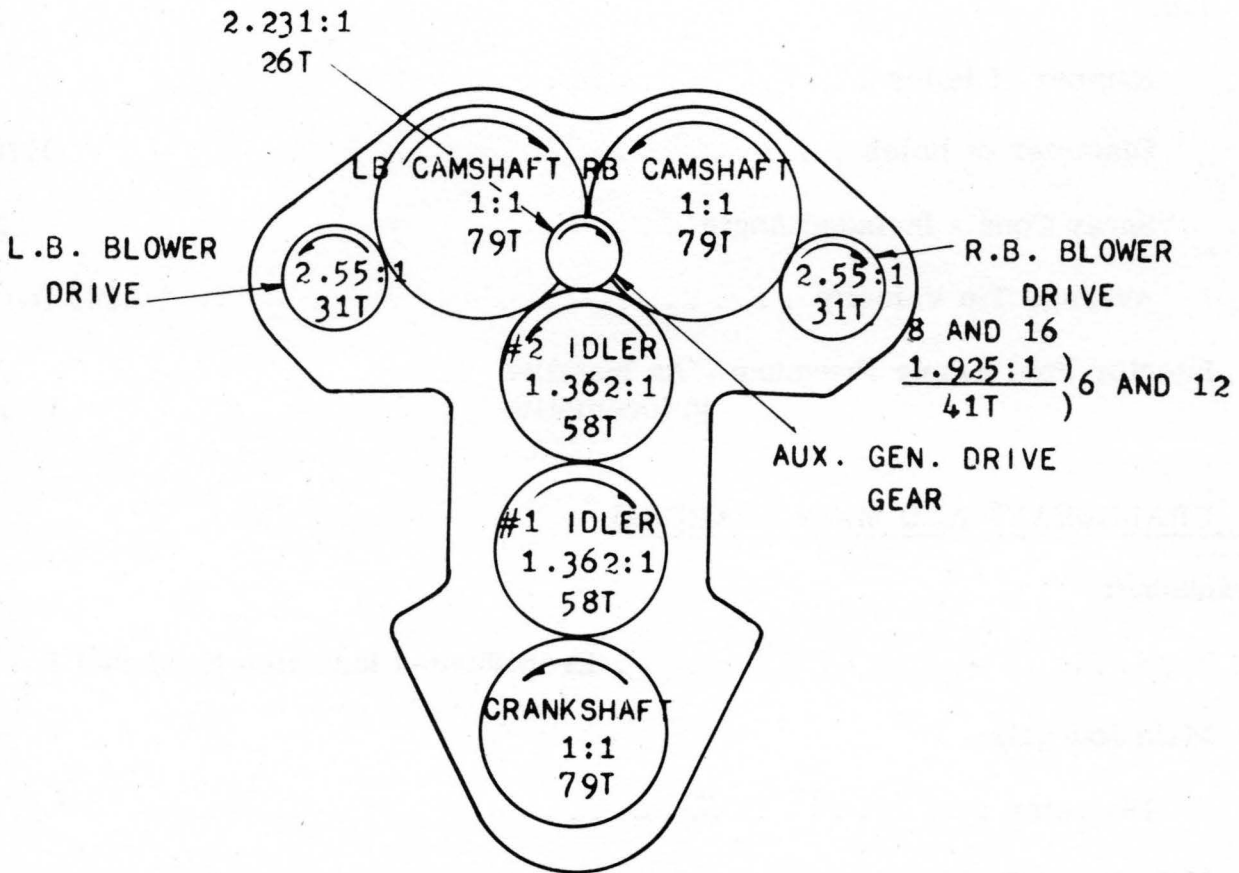

SPEED RATIO, NUMBER OF TEETH

Gear Tooth Data:

Type . . . . .	20° Involute
Diametral Pitch . . . . .	4

VI. CAMSHAFT AND BLOWER DRIVE GEAR TRAIN (Continued)

Face Width:

Upper Idler Gear . . . . .	4-1/2 in.
Auxiliary Generator Drive Gear . . . . .	1-1/4 in.
All Others. . . . .	3 in.

VII. ACCESSORY DRIVE GEAR TRAIN

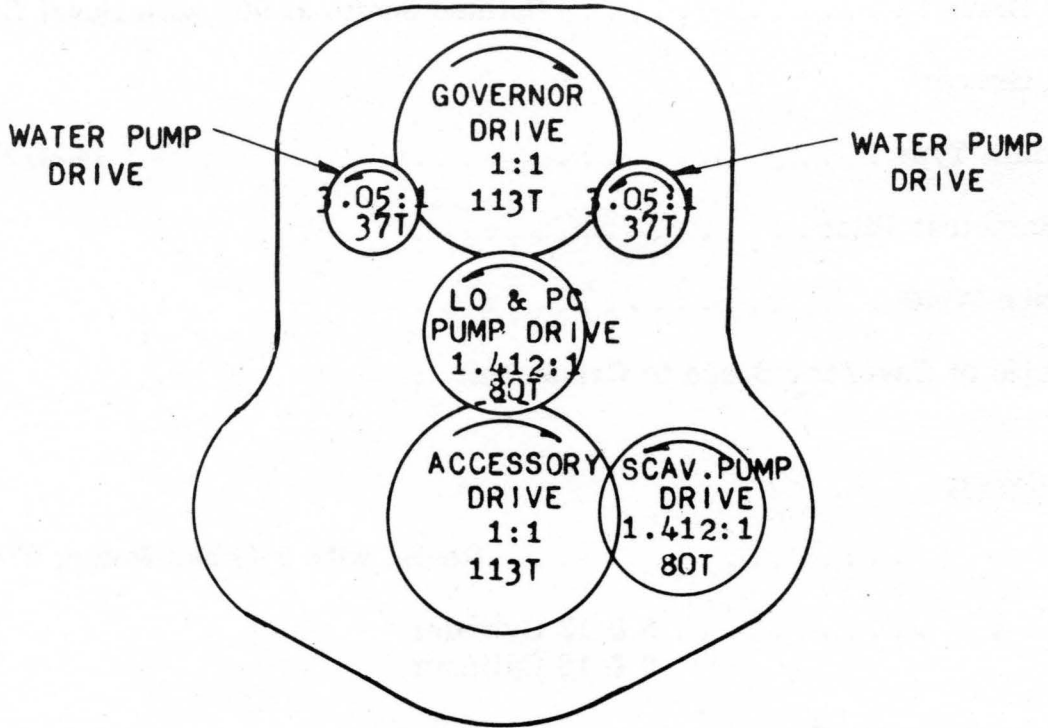

SPEED RATIO, NUMBER OF TEETH

Gear Tooth Data:

Type . . . . .	20° Involute
Diametral Pitch . . . . .	7.3084

## VII. ACCESSORY DRIVE GEAR TRAIN (Continued)

Face Width . . . . .	2 in.
Accessory Drive Gear:	
Power Transmitted from Rim to Hub by Spring Packs:	
Number of Packs . . . . .	8
Springs per Pack . . . . .	19
Spring Thickness . . . . .	.020 in.
Spring Lubrication . . . . .	Main Bearing Oil Pressure
Governor Drive Gear:	
I.D. of Pressed-In Bushing . . . . .	5 in.
Governor Drive . . . . . Splined Shafts at 90° with Bevel Gear Drive	
Bevel Gears:	
Tooth Type . . . . .	14-1/2° Involute
Diametral Pitch . . . . .	8
Face Width . . . . .	3/4 in.
Ratio of Governor Speed to Crankshaft . .	1.09:1

## VIII. BLOWER

Type . . . . .	Roots, with 3 Lobed Rotor, 9°40' Spiral
Speed . . . . .	6 & 12 Cylinder 1540 8 & 16 Cylinder 2040
Actual Capacity - See Curve	
Blower Timing Gears:	
Tooth Type . . . . .	14-1/2° Involute Spur
Helix Angle . . . . .	45°19'18"



### VIII. BLOWER (Continued)

Pitch Diameter . . . . .	8 in.
Diametral Pitch . . . . .	8
Face Width. . . . .	1-3/4 in.

### IX. LUBE OIL SYSTEM

Lubricating Oil and Piston Cooling Pumps . . . . . Single Shaft Drives  
Two-Gear Type Pumps with Siamesed Inlet and Double Discharge

Scavenging Pumps . . . . . Gear Pump with Two Sets of Gears Mounted in  
Herringbone Pattern

#### Gear Tooth Data:

Tooth Type. . . . .	28 <sup>0</sup> Involute with 10 <sup>0</sup> Spiral Angle
Diametral Pitch . . . . .	4
Speed . . . . .	1130 R.P.M.
Efficiency . . . . .	93%
Lube Oil and Piston Cooling Pump Suction . . . . .	0.5 in. Hg. Max
Pressure at Rated Speed:	
Lubricating Oil . . . . .	60-65 p.s.i.
Piston Cooling Oil . . . . .	30 p.s.i.
Scavenging Oil . . . . .	20 p.s.i.
Diameter Nozzle in Piston Cooling Tube. . . . .	3/16 in.
Lube Oil System Capacity . . . . .	12-1/2 Gal/Cyl.

### X. WATER PUMPS

Type . . . . .	Centrifugal
Capacity per Pump - Engine Installed in Locomotive	See Curve
Discharge Pressure - Installed in Locomotive. .	20-30 p.s.i.

**X. WATER PUMPS (Continued)**

Intake Suction - Installed Locomotive. . . . .	Negligible
Pump Speed at 800 R.P.M. Engine Speed. . . . .	2440 R.P.M.

**XI. GOVERNOR**

Type . . . . .	P.G.
Manufactured by. . . . .	Woodward Governor Company
Speed at 800 R.P.M. Engine Speed. . . . .	872 R.P.M.
Oil Capacity . . . . .	3-1/2 pints
Type Lubricant . . . . .	SAE 30-40
Power Piston Travel. . . . .	1.00 in.

**XII. FUEL OIL SPECIFICATIONS**

These recommendations are based on correlations obtained in the operation of subject engines through the years. An attempt has been made to balance the fuel that is required for efficient low maintenance operation of the engine with the fuel that the Petroleum Industry can economically produce. We are, therefore, submitting these recommendations on fuel limitations as an equitable basis for the procurement of diesel fuels for these engines.

## XII. FUEL OIL SPECIFICATIONS (Continued)

### RECOMMENDED LIMITS FOR DIESEL FUEL

<u>Method of Test</u>	<u>ASTM Designation</u>	<u>Limits</u>
Cetane Number	D-613	45 (Min.) - See Note 1
90% Boiling Point	D-158	65 <sup>o</sup> F. (Max.) - See Note 1
Final Boiling Point, <sup>o</sup> F	D-158	700 <sup>o</sup> F. (Max.) - See Note 2
Distillation Recovery	D-158	97.5% (Minimum)
Total Sulfur	D-129	0.75% (Maximum)
Corrosive Sulfur	Modified	
(3 Hr. @ 212 <sup>o</sup> F.)	D-150	Passes
Conradson Carbon Residue	D-189	0.15% (Maximum)
(on 10% Bottoms)		
Water and Sediment	D-96	0.05% (Maximum)
Cloud and Pour Point, <sup>o</sup> F.	D-97	See Note 3
Flash Point, <sup>o</sup> F.	D-93	150 <sup>o</sup> F. (Minimum)

#### NOTE 1:

In order to give the purchaser the widest possible latitude in selecting a satisfactory fuel, the table given below shows the relationship between volatility and ignition quality in terms of 90% Boiling Point and Cetane Number. These fuels are grouped into four classifications, three of which, as seen below, are usable fuels in subject engines:

#### CETANE NUMBER BELOW 40 - LOW QUALITY

This fuel is not recommended for use in subject engines at this time.

#### CETANE NUMBER BETWEEN 40 and 45 - DOUBTFUL QUALITY

Usage of this fuel should be limited as follows:

1. The 90% Boiling Point should not be over thirteen times the Cetane Number (90% Boiling Point <sup>o</sup>F. per A.S.T.M. D-158).
2. The higher cetane values in this range would be preferred. The usage of fuels in this range should be accompanied by rather close engine observation regarding cleanliness and general maintenance. The engine manufacturer will assist the user in any such observations.

## XII. FUEL OIL SPECIFICATIONS (Continued)

### CETANE NUMBER BETWEEN 45 and 50 - RECOMMENDED QUALITY

This range fuel is well adapted to average operation. Its usage should have the 90% Boiling Point not over thirteen times the Cetane Number, as outlined above.

This fuel should give well balanced economy from a maintenance and fuel cost basis.

### CETANE NUMBER ABOVE 50 - EXTRA HIGH QUALITY

The 90% Boiling Point Limit shall be 650° F. maximum, not regarding 90% Point (°F.) ÷ Cetane Number relationship, since it will be less than thirteen. The usage of fuel in this range should be accompanied by rather close observation, in order to establish the true value on a maintenance and fuel cost basis. The use of fuels of over 50 Cetane, while not detrimental, will not materially improve engine performance. Therefore, the user is not justified in paying a premium for fuels of higher than 50 Cetane.

#### NOTE 2:

The maximum Final Boiling Point or End Point has been recommended as 700° F. for all fuels. The use of a 90% Point (°F.) ÷ Cetane Number relationship instead of the former End Point (°F.) ÷ Cetane Number is justified on the basis of the much better reproductibility of the 90% Point. Retaining the fact at "13" will permit a wider selection of fuels, based on the 90% Point over Cetane Number.

#### NOTE 3:

The "Cloud and Pour Points" of a fuel are measures of its fluidity at low temperature. To insure flow at the lowest estimated fuel temperature, the purchaser shall specify the minimum "Cloud or Pour Point" requirements.

### GENERAL NOTES

- I. It is desired that fuel be free from acid, which when in contact with any metal forms soap in sufficient quantity to plug the fuel filters.
- II. The indiscriminate use of Cetane improvers or other fuel additives should be limited until tests have established any detrimental effects. Such tests would include observation of engine wear, corrosion or excess deposits. A coordinated effort will be made by the engine manufacturer to assist in the observation of these tests.

## XII. FUEL OIL SPECIFICATION (Continued)

- III. Laboratory gum determinations are not listed as present test procedures due to the lack of correlation between the methods and/or the condition of the engine after operation. Since obviously this may be an important phase of the diesel fuel procurement problem, the engine manufacturer is working to obtain laboratory and engine test correlation.
- IV. The quality, uniformity and dependability of the diesel fuel are responsibilities of the supplier. However, the engine manufacturer, the petroleum refiner and the railroad user are all concerned in selection of the fuel.

## XIII. LUBRICATING OIL SPECIFICATIONS

Engine lubricating oil used in Electro-Motive locomotives should be obtained from reputable oil companies to meet the following specifications:

### VISCOSITY CLASSIFICATION OF OIL - SAE 40

<u>Method of Test</u>	<u>ASTM Designation</u>	<u>Limits</u>
Viscosity-Saybolt Universal	D88 or D446	
A. Seconds at 100 <sup>o</sup> F.		1300 (Maximum)
B. Seconds at 210 <sup>o</sup> F.		74 (Minimum)
Viscosity Index	D567	35 (Minimum) 75 (Maximum)
Flash Point, Degrees F.	D92	420 <sup>o</sup> F. (Minimum)
Fire Point, Degrees F.	D92	475 <sup>o</sup> F. (Minimum)
Pour Point, Degrees F.	D97	40 <sup>o</sup> F. (Maximum)

The oil must have an inherent high resistance to oxidation, a low tendency toward the formation of carbon deposits and shall be non-corrosive to copper-lead bearings at 230<sup>o</sup> F. and to silver metal at 285<sup>o</sup> F.

(Refer to Maintenance Instruction No. 1607, Revision E, for further information).